

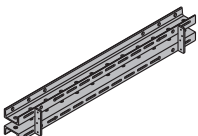
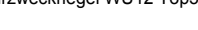
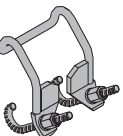

	[kg]	Article n°
Multi-purpose waling WS10 Top50 1.00m	19.6	580003000
Multi-purpose waling WS10 Top50 1.25m	24.7	580004000
Mehrweckriegel WS10 Top50		
 Painted blue		

Multi-purpose waling WU12 Top50 1.50m	37.5	580020000
Multi-purpose waling WU12 Top50 1.75m	44.2	580021000
Mehrweckriegel WU12 Top50		
 Painted blue		

Flange clamp H20	1.0	580135000
Flanschklammer H20		
 Galvanised		
Width: 13 cm		
Width-across: 19 mm		

Flange clamp G	1.1	580120000
Flanschklammer G		
 Galvanised		
Width: 13 cm		
Width-across: 19 mm		

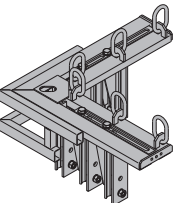

Lifting bracket	6.2	580460000
Kranöse		
 Galvanised		
Height: 59 cm		

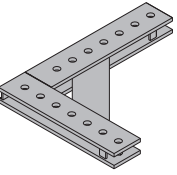

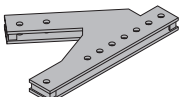
Lifting bracket for column formwork	65.0	580607000
Kranöse für Stützenschalung		
 Galvanised, powder-coated		
Length: 85 cm		
Width: 85 cm		

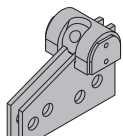
Corner connecting plate 90/50	13.8	580603000
Winkellasche 90/50		
 Painted blue		
Length: 51 cm		
Width: 40 cm		

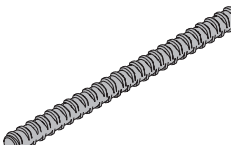
	[kg]	Article n°
Column connecting plate 6/8	15.0	580072000
Stützenlasche 6/8		
 Painted blue		
Length: 58 cm		

Universal angle tie bracket	4.4	580604000
Universal-Winkelspanner		
 Painted blue		
Length: 20 cm		

Tie rod 15.0mm galvanised 1.00m	1.4	581823000
Tie rod 15.0mm non-treated 1.00m	1.4	581874000
Ankerstab 15,0mm 1,0m		
 		

Wing nut 15.0	0.31	581961000
Flügelmutter 15,0		
 Galvanised		
Length: 10 cm		
Height: 5 cm		
Width-across: 27 mm		
		

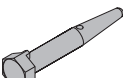
Connecting pin 10cm	0.34	580201000
Verbindungsbolzen 10cm		
 Galvanised		
Length: 14 cm		

Spring cotter 5mm	0.05	580204000
Federvorstecker 5mm		
 Galvanised		
Length: 13 cm		

Panel strut 340 IB	24.3	580365000
Elementstütze 340 IB		
consisting of:		
(A) Plumbing strut 340 IB	16.7	588696000
Galvanised		
Length: 190.8 - 341.8 cm		
(B) Adjusting strut 120 IB	7.6	588248500
Galvanised		
Length: 81.5 - 130.6 cm		

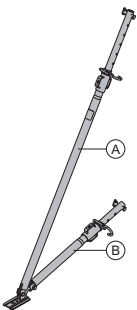
 Galvanised		
Delivery condition: folded closed		

Panel strut 540 IB

Elementstütze 540 IB

consisting of:

(A) Plumbing strut 540 IB

Galvanised

Length: 310.5 - 549.2 cm

(B) Adjusting strut 220 IB

Galvanised

Length: 172.5 - 221.1 cm

Galvanised

Delivery condition: folded closed

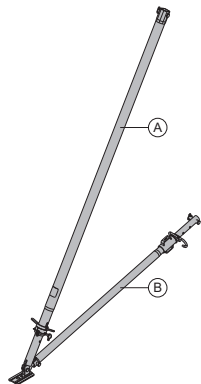
**41.4 580366000****30.7 588697000****10.9 588251500****Eurex 60 550**

Eurex 60 550

depending on length, comprising:

(A) Plumbing strut Eurex 60 550

Powder-coated, blue

Aluminium

Length: 343 - 553 cm

(B) Extension Eurex 60 2.00m

Powder-coated, blue

Aluminium

Length: 250 cm

(C) Coupler Eurex 60

Aluminium

Length: 100 cm

Diameter: 12.8 cm

(D) Connector Eurex 60 IB

Galvanised

Length: 15 cm

Width: 15 cm

Height: 30 cm

(E) Plumbing strut shoe Eurex 60 EB

Galvanised

Length: 31 cm

Width: 12 cm

Height: 33 cm

(F) Adjusting strut 540 Eurex 60 IB

Galvanised

Length: 303.5 - 542.2 cm

Delivery condition: separate parts

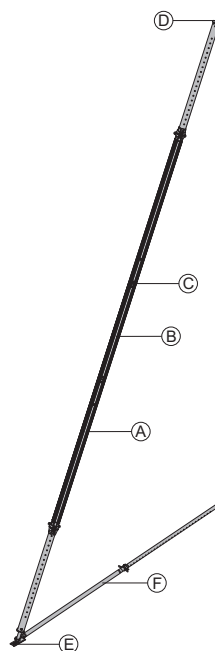
**Prop head EB**

Stützenkopf EB

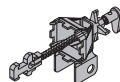
3.1 588244500

Galvanised

Length: 40.8 cm

Width: 11.8 cm

Height: 17.6 cm

Universal dismantling tool

Universal-Lösewerkzeug

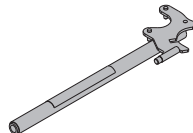
3.7 582768000

Galvanised

Length: 75.5 cm

[kg] Article n°

Doka express anchor 16x125mm

Doka-Expressanker 16x125mm

0.31 588631000

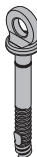
Galvanised
Length: 18 cm
Follow fitting instructions!**Doka coil 16mm**

Doka-Coil 16mm

0.009 588633000

Galvanised
Diameter: 1.6 cm**Top scaffold bracket L**

Betonierkonsole L

12.6 587153500

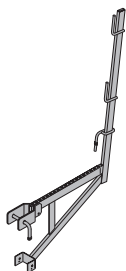
Galvanised
Length: 101 cm
Height: 159 cm**Universal bracket 60**

Universal-Konsole 60

14.0 580477000

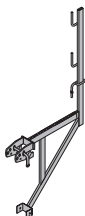
Galvanised
Length: 86 cm
Height: 181 cm**Universal bracket 90**

Universal-Konsole 90

30.4 580476000

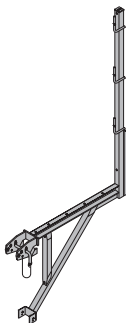
Galvanised
Length: 121 cm
Height: 235 cm**Universal railing shackle**

Universal-Geländerbügel

3.0 580478000

Galvanised
Height: 20 cm

Scaffold tube 48.3mm 0.50m

1.7 682026000

Scaffold tube 48.3mm 1.00m

3.6 682014000

Scaffold tube 48.3mm 1.50m

5.4 682015000

Scaffold tube 48.3mm 2.00m

7.2 682016000

Scaffold tube 48.3mm 2.50m

9.0 682017000

Scaffold tube 48.3mm 3.00m

10.8 682018000

Scaffold tube 48.3mm 3.50m

12.6 682019000

Scaffold tube 48.3mm 4.00m

14.4 682021000

Scaffold tube 48.3mm 4.50m

16.2 682022000

Scaffold tube 48.3mm 5.00m

18.0 682023000

Scaffold tube 48.3mm 5.50m

19.8 682024000

Scaffold tube 48.3mm 6.00m

21.6 682025000

Scaffold tube 48.3mmm

3.6 682001000

Gerüstrohr 48,3mm

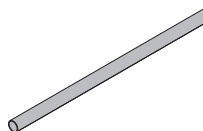

Galvanised

Scaffold tube connection

Gerüstrohranschluss

0.27 584375000

Galvanised
Height: 7 cm**Screw-on coupler 48mm 50**

Anschraubkupplung 48mm 50

0.84 682002000

Galvanised
Width-across: 22 mm**Tool box GF**

GF-Werkzeugbox

6.5 580390000

included in scope of supply:

(A) Reversible ratchet 1/2"

0.73 580580000

Galvanised

Length: 30 cm

(B) Fork wrench 13/17

0.08 580577000

(C) Fork wrench 22/24

0.22 580587000

(D) Fork wrench 30/32

0.80 580897000

(E) Ring spanner 17/19

0.27 580590000

(F) Extension 11cm 1/2"

0.20 580581000

(G) Extension 22cm 1/2"

0.31 580582000

(H) Universal joint coupling

0.16 580583000

(I) Box nut 19 1/2" L

0.16 580598000

(J) Box nut 13 1/2"

0.06 580576000

(K) Box nut 24 1/2"

0.12 580584000

(L) Box nut 30 1/2"

0.20 580575000

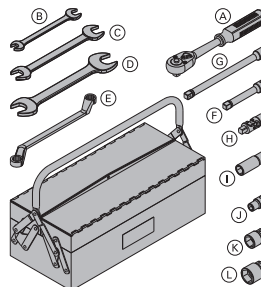
**Assembly angle Top50**

Montagelasche Top50

6.7 580082000

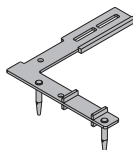
Galvanised
Length: 53.2 cm
Width: 48.6 cm

Strip tensioner B 5.00m

Bandzwinge B 5,00m

3.5 580394000

Galvanised

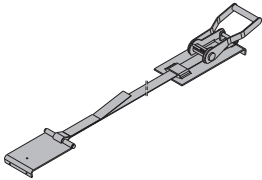
**Hole gauge Top50**

Bohrplatte Top50

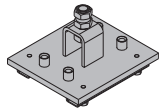
2.9 580080000

Painted blue

Length: 17 cm

Width: 15 cm

Tool: Drill bit (diameter 10 mm)

Positioning railm

Führungsschienem

1.8 580079000

Painted blue

Weight per linear metre

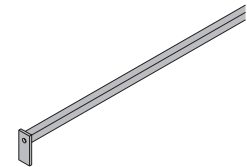
**Angle connector 9x5cm**

Winkelverbinder 9x5cm

0.22 580381000

Galvanised

**Rafter plate right**

Rafter plate left

Sparrenpfettenanker

0.09 582521000**0.09 582522000**

Galvanised

Length: 17 cm

**Doka 4-part chain 3.20m**

Doka-Vierstrangkette 3,20m

15.0 588620000

Follow the directions in the "Operating Instructions"!

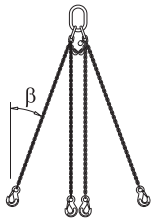
**Doka Safety Systems**

You will find working and protection platforms, guardrail systems and access systems in the section headed "Doka Safety Systems".