

	[kg]	Article n°
Supporting construct. frame "Variable" 3.30m Abstützbock Variabel 3,30m	187.8	580516000
consisting of:		
(A) Waling WU14 for supporting construction frame 99.0	580510000	
Painted blue Height: 252 cm		
(B) Multi-purpose waling WS10 Top50 2.00m	38.9	580007000
Painted blue		
(C) Tension plate	2.5	580534000
Painted blue Length: 19 cm		
(D) Supporting shoe	9.5	580532000
Painted blue Length: 28 cm		
(E) Connecting pin 10cm	0.34	580201000
Galvanised Length: 14 cm		
(F) Spring cotter 5mm	0.05	580204000
Galvanised Length: 13 cm		
(G) Spindle strut 12 3.00m	32.0	580521000
Painted blue Length: 201 - 234 cm		
(H) Screw-on coupler 48mm 50	0.84	682002000
Galvanised Width-across: 22 mm Follow fitting instructions!		

Painted blue

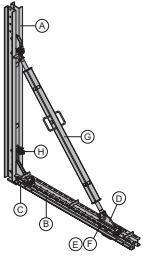

Waling WU14 for supporting construction frame Abstützbockriegel WU14	99.0	580510000
consisting of:		
(A) Steel section WU14 f. supp. constr. frame	81.0	580509000
Painted blue Height: 250 cm		
(B) Pressure shoe	6.2	580531000
Painted blue Height: 32 cm		
(C) Anchoring shoe	12.0	580533000
Painted blue Height: 51 cm		

Painted blue
Height: 252 cm

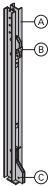

Supporting shoe Stütزشuh	9.5	580532000
Painted blue Length: 28 cm		



Tension plate Zuglasche	2.5	580534000
Painted blue Length: 19 cm		



Multi-purpose waling WS10 Top50 1.00m	19.6	580003000
Multi-purpose waling WS10 Top50 1.75m	35.0	580006000
Multi-purpose waling WS10 Top50 2.00m	38.9	580007000
Multi-purpose waling WS10 Top50 2.50m	48.7	580009000
Multi-purpose waling WS10 Top50 2.75m	54.2	580010000
Multi-purpose waling WS10 Top50 3.00m	58.9	580011000
Multi-purpose waling WS10 Top50 3.50m	68.4	580012000
Multi-purpose waling WS10 Top50 4.00m	79.4	580013000
Mehrzweckriegel WS10 Top50		

Painted blue

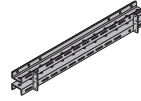

Spindle strut 12 3.00m Spindelstrebe 12 3,00m	32.0	580521000
---	------	------------------

Painted blue
Length: 201 - 234 cm



Spindle strut T7 305/355cm Spindelstrebe T7 305/355cm	35.0	584327000
---	------	------------------

Galvanised

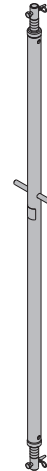

Formwork element connector FF20/50 Z Elementverbinder FF20/50 Z	6.0	587533000
---	-----	------------------

Painted blue
Length: 55 cm

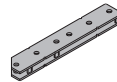

Connecting pin 10cm Verbindungsbolzen 10cm	0.34	580201000
--	------	------------------

Galvanised
Length: 14 cm



Spring cotter 5mm Federvorstecker 5mm	0.05	580204000
---	------	------------------

Galvanised
Length: 13 cm



Supporting construction distancer 20cm Bockdistanz 20cm	9.4	580519000
---	-----	------------------

Galvanised
Length: 25 cm
Width: 19 cm
Height: 20 cm



Waling-to-bracket holder 9-15cm Riegelhalter 9-15cm	[kg]	Article n°
	2.7	580625000



Galvanised

Framax universal fixing bolt 10-16cm Framax-Universalverbinder 10-16cm	0.60	588158000
--	------	------------------



Galvanised
Length: 26 cm

Framax universal fixing bolt 10-25cm Framax-Universalverbinder 10-25cm	0.69	583002000
--	------	------------------



Galvanised
Length: 36 cm

Framax wedge clamp Framax-Spannklemme	1.5	588152000
---	-----	------------------



Galvanised
Length: 21 cm

Screw-on coupler 48mm 50	0.84	682002000
Screw-on coupler 48mm 95 Anschraubkupplung	0.88	586013000

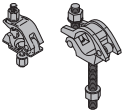

Galvanised
Width-across: 22 mm
Follow fitting instructions!

Swivel coupler 48mm Drehkupplung 48mm	1.5	582560000
---	-----	------------------



Galvanised
Width-across: 22 mm
Follow fitting instructions!

Scaffold tube 48.3mm 0.50m	1.7	682026000
Scaffold tube 48.3mm 1.00m	3.6	682014000
Scaffold tube 48.3mm 1.50m	5.4	682015000
Scaffold tube 48.3mm 2.00m	7.2	682016000
Scaffold tube 48.3mm 2.50m	9.0	682017000
Scaffold tube 48.3mm 3.00m	10.8	682018000
Scaffold tube 48.3mm 3.50m	12.6	682019000
Scaffold tube 48.3mm 4.00m	14.4	682021000
Scaffold tube 48.3mm 4.50m	16.2	682022000
Scaffold tube 48.3mm 5.00m	18.0	682023000
Scaffold tube 48.3mm 5.50m	19.8	682024000
Scaffold tube 48.3mm 6.00m	21.6	682025000
Scaffold tube 48.3mmm Gerüstrohr 48,3mm	3.6	682001000

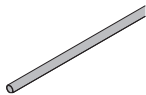

Galvanised

Screw-on access bracket MF75 Anschraubbühne MF75	19.0	580669000
--	------	------------------



Galvanised
Length: 113 cm
Height: 152 cm

Swivel plate MF Schwenkplatte MF	4.5	580672000
--	-----	------------------



Galvanised
Length: 29 cm
Height: 20 cm

Testing truss for diagonal anchors 15.0/20.0 Prüfbock für Schräganker 15,0/20,0	[kg]	Article n°
	13.5	580514000

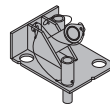

Galvanised
Length: 32 cm
Width: 25 cm
Height: 19 cm

Universal tool box 15.0 Universal-Werkzeugbox 15,0	9.1	580392000
--	-----	------------------

included in scope of supply:

(A) Reversible ratchet 1/2" Galvanised Length: 30 cm	0.73	580580000
(B) Fork wrench 13/17	0.08	580577000
(C) Fork wrench 22/24	0.22	580587000
(D) Fork wrench 30/32	0.80	580897000
(E) Fork wrench 36/41	1.0	580586000
(F) Ring spanner 17/19	0.27	580590000
(G) Square nut 22	0.31	580589000
(H) Box spanner 41	0.99	580585000
(I) Extension 11cm 1/2"	0.20	580581000
(J) Extension 22cm 1/2"	0.31	580582000
(K) Universal joint coupling 1/2"	0.16	580583000
(L) Box nut 19 1/2" L	0.16	580598000
(M) Box nut 13 1/2"	0.06	580576000
(N) Box nut 24 1/2"	0.12	580584000
(O) Box nut 30 1/2"	0.20	580575000
(P) Positioning cone spanner 15.0 DK Galvanised Length: 8 cm Width-across: 30 mm	0.30	580579000

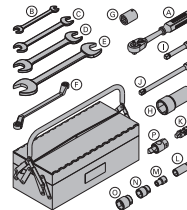

	[kg]	Article n°
Supporting construct. frame Universal F 4.50m Abstützbock-Universal F 4,50m	306.0	580500000
Painted blue Length: 196 cm Height: 365 - 394 cm		
		

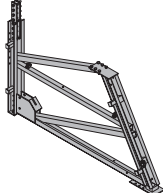
Attachable frame F 1.50m Anbaurahmen F 1,50m	236.0	580502000
Painted blue Length: 280 cm		
		

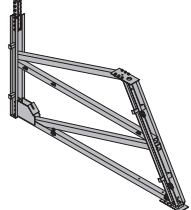
Attachable frame F 2.00m Anbaurahmen F 2,00m	451.0	580501000
Painted blue Length: 394 cm		
		

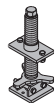
Front spindle for supp. construction frame Abstützbockspindel vorne	17.0	580508000
Galvanised		
		

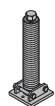
Rear spindle for supp. construction frame Abstützbockspindel hinten	18.3	580515000
Galvanised		
		

Anchor waling 0.70m	27.0	580517000
Anchor waling 1.95m	76.3	580545000
Anchor waling 2.95m Ankerriegel	110.0	580546000
Painted blue		
		

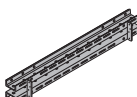
Multi-purpose waling WS10 Top50 1.00m	19.6	580003000
Multi-purpose waling WS10 Top50 1.75m	35.0	580006000
Multi-purpose waling WS10 Top50 2.00m	38.9	580007000
Multi-purpose waling WS10 Top50 2.50m	48.7	580009000
Multi-purpose waling WS10 Top50 2.75m	54.2	580010000
Multi-purpose waling WS10 Top50 3.00m	58.9	580011000
Multi-purpose waling WS10 Top50 3.50m	68.4	580012000
Multi-purpose waling WS10 Top50 4.00m Mehrzweckriegel WS10 Top50	79.4	580013000
Painted blue		
		

	[kg]	Article n°
Multi-purpose waling WU12 Top50 2.00m	50.0	580022000
Multi-purpose waling WU12 Top50 3.00m Mehrzweckriegel WU12 Top50	75.7	580024000
Painted blue		

Anchoring profile 0.55m Ankerprofil 0,55m	44.5	582904000
Painted blue		
		

Anchor waling positioner Ankerriegelhalter	0.62	580539000
Galvanised Length: 31 cm		
		

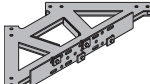
Corner plate supporting constr. frame Ecklasche Abstützbock	44.4	580518000
Painted blue Length: 92 cm Width: 92 cm		
		

Supporting construction distancer 20cm Bockdistanz 20cm	9.4	580519000
Galvanised Length: 25 cm Width: 19 cm Height: 20 cm		
		

Clamp for supp. constr. distancer 20cm Klemme für Bockdistanz 20cm	5.0	582920000
Galvanised Length: 36 cm Width: 7 cm		
		

Waling-to-bracket holder 9-15cm Riegelhalter 9-15cm	2.7	580625000
Galvanised		
		

Framax universal fixing bolt 10-16cm Framax-Universalverbinder 10-16cm	0.60	588158000
Galvanised Length: 26 cm		
		

Framax universal fixing bolt 10-25cm Framax-Universalverbinder 10-25cm	0.69	583002000
Galvanised Length: 36 cm		
		

Framax wedge clamp Framax-Spannklemme	1.5	588152000
Galvanised Length: 21 cm		
		

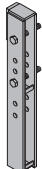
Framax supporting construct. frame connector Framax-Bocklasche	15.0	580506000
Painted blue Height: 77 cm		
		

Framax supporting construct. frame bolt 36cm Framax-Bockschraube 36cm	[kg]	Article n°
	0.62	580505000
	Galvanised	

Attachable roller 200 Ansteckrolle 200	19.3	580538000
	Painted blue Height: 38 cm	

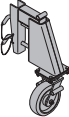
Attachable roller 250 Ansteckrolle 250	47.0	580537000
	Painted blue Height: 78 cm	

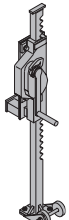
Winch with transport device Hubwinde mit Transportroller	37.0	580541000
	Painted blue Height: 127 cm Follow the directions in the "Operating Instructions"!	CE

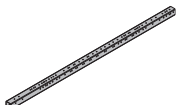
Travelling profile F 2.00m front Verfahrprofil F 2,00m vorne	180.0	582925000
	Galvanised Length: 600 cm	

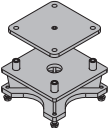
Wheel connector F 2.00m front Radanschluss F 2,00m vorne	33.7	582926000
	Galvanised Length: 30 cm Width: 30 cm Height: 16.5 cm	

Clamping jaw F 2.00m Klemmbacke F 2,00m	0.82	582927000
	Galvanised Length: 12.5 cm	

Clamping plate F 2.00m Klemmplatte F 2,00m	3.5	582928000
	Galvanised Length: 24 cm	

Intermediate plate F 2.00m Zwischenplatte F 2,00m	6.0	582929000
	Galvanised Length: 25 cm Width: 18 cm	

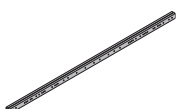
Travelling profile F 2.00m rear Verfahrprofil F 2,00m hinten	187.5	582930000
	Galvanised Length: 574 cm	

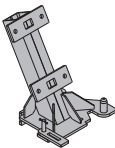
Wheel connector F 2.00m rear Radanschluss F 2,00m hinten	44.5	582931000
	Galvanised Height: 61.5 cm	

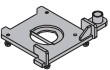

Connection plate F 2.00m Anschlussplatte F 2,00m	15.8	582932000
	Galvanised Length: 44.1 cm Width: 35.7 cm	

Bolting plate F 2.00m Schraubplatte F 2,00m	2.9	582933000
	Galvanised Length: 20 cm	

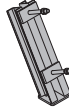
Connector plate F 2.00m Verbindungsplatte F 2,00m	2.3	582934000
	Galvanised Length: 42 cm	

Lifting bracket F 2.00m rear Hubkonsole F 2,00m hinten	14.0	582935000
	Galvanised Height: 48.6 cm	

Suspension shoe for horiz. supp.constr. frame Aufhängeschuh Abstützbock horizontal	11.0	580530000
	Painted blue Length: 45 cm	

Screw-on coupler 48mm 50 Screw-on coupler 48mm 95 Anschraubkupplung	0.84 0.88	682002000 586013000
 	Galvanised Width-across: 22 mm Follow fitting instructions!	

Swivel coupler 48mm Drehkupplung 48mm	1.5	582560000
	Galvanised Width-across: 22 mm Follow fitting instructions!	

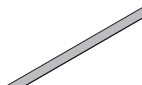
Scaffold tube 48.3mm 0.50m	1.7	682026000
Scaffold tube 48.3mm 1.00m	3.6	682014000
Scaffold tube 48.3mm 1.50m	5.4	682015000
Scaffold tube 48.3mm 2.00m	7.2	682016000
Scaffold tube 48.3mm 2.50m	9.0	682017000
Scaffold tube 48.3mm 3.00m	10.8	682018000
Scaffold tube 48.3mm 3.50m	12.6	682019000
Scaffold tube 48.3mm 4.00m	14.4	682021000
Scaffold tube 48.3mm 4.50m	16.2	682022000
Scaffold tube 48.3mm 5.00m	18.0	682023000
Scaffold tube 48.3mm 5.50m	19.8	682024000
Scaffold tube 48.3mm 6.00m	21.6	682025000
Scaffold tube 48.3mmm	3.6	682001000
Gerüstrohr 48,3mm		
	Galvanised	

	[kg]	Article n°
Screw-on access bracket MF75 Anschraubbühne MF75	19.0	580669000
	Galvanised Length: 113 cm Height: 152 cm	

Swivel plate MF Schwenkplatte MF	4.5	580672000
	Galvanised Length: 29 cm Height: 20 cm	

Handrail clamp S Schutzgeländerzwinge S	11.5	580470000
	Galvanised Height: 123 - 171 cm	

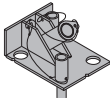
Testing truss for diagonal anchors 15.0/20.0 Prüfbock für Schräganker 15,0/20,0	13.5	580514000
	Galvanised Length: 32 cm Width: 25 cm Height: 19 cm	

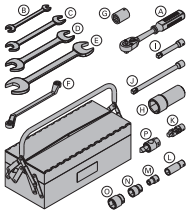
Universal tool box 15.0 Universal-Werkzeugbox 15,0 included in scope of supply:	9.1	580392000
(A) Reversible ratchet 1/2" Galvanised Length: 30 cm	0.73	580580000
(B) Fork wrench 13/17	0.08	580577000
(C) Fork wrench 22/24	0.22	580587000
(D) Fork wrench 30/32	0.80	580897000
(E) Fork wrench 36/41	1.0	580586000
(F) Ring spanner 17/19	0.27	580590000
(G) Square nut 22	0.31	580589000
(H) Box spanner 41	0.99	580585000
(I) Extension 11cm 1/2"	0.20	580581000
(J) Extension 22cm 1/2"	0.31	580582000
(K) Universal joint coupling 1/2"	0.16	580583000
(L) Box nut 19 1/2" L	0.16	580598000
(M) Box nut 13 1/2"	0.06	580576000
(N) Box nut 24 1/2"	0.12	580584000
(O) Box nut 30 1/2"	0.20	580575000
(P) Positioning cone spanner 15.0 DK Galvanised Length: 8 cm Width-across: 30 mm	0.30	580579000
		

Reversible ratchet 3/4" Umschaltknarre 3/4"	1.5	580894000
	Galvanised Length: 50 cm	

	[kg]	Article n°
Box nut 46 3/4" Stecknuss 46 3/4"	0.70	580512000

Extension 20cm 3/4" Verlängerung 20cm 3/4"	0.68	580683000

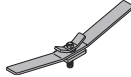
Cone spanner 20.0 Konusschlüssel 20,0	3.5	581471000
	Galvanised Length: 57 cm	

Clearance-cone dismantling tool Lösewerkzeug Freistellkonus	0.67	581864000
	Galvanised Length: 10.7 cm Width-across: 24 mm	

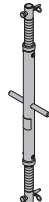
Spindle strut T6 100/150cm Spindelstrebe T6 100/150cm	12.5	584323000
	Galvanised	

Spindle strut T7 100/150cm Spindelstrebe T7 100/150cm	16.8	584309000
	Galvanised	

Spindle strut T7 200/250cm Spindelstrebe T7 200/250cm	26.2	584325000
	Galvanised	

[kg] Article n°
Spindle strut T7 250/300cm 29.4 **584326000**
Spindelstrebe T7 250/300cm

Galvanised

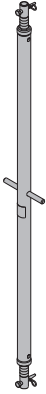

Spindle strut T10 350/400cm 57.5 **584328000**
Spindelstrebe T10 350/400cm

Galvanised

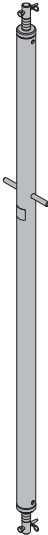

Spindle strut SL-1 T16 100/140cm 54.1 **582871000**
Spindelstrebe SL-1 T16 100/140cm

Galvanised



Spindle strut SL-1 T16 140/225cm 87.8 **582872000**
Spindelstrebe SL-1 T16 140/225cm

Galvanised

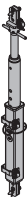

[kg] Article n°
Spindle strut SL-1 T16 220/375cm 123.0 **582874000**
Spindelstrebe SL-1 T16 220/375cm

Galvanised



Attachable frame F 2.40m 1107.0 **582910000**
Anbaurahmen F 2,40m

Painted blue
Length: 576 cm

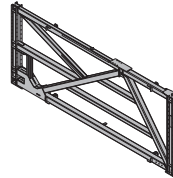

Stacking plate F 2.40m 32.5 **582902000**
Aufstocklasche F 2,40m

Painted blue
Height: 63.5 cm



Spindle for attachable frame F 2.40m 20.1 **582903000**
Spindel für Anbaurahmen F 2,40m

Galvanised
Height: 47.5 cm



Lowering wedge 1000kN 53.5 **582905000**
Absenckeil 1000kN

Painted blue
Height: 19.2 - 27.2 cm

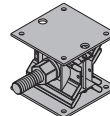

Ring spanner 80 3.8 **582906000**
Ringschlüssel 80

Galvanised
Length: 62.4 cm



Bracing profile 2.95m 42.5 **582907000**
Verschwertungsprofil 2,95m

Painted blue



Platform profile 1.00m f. supp. constr. frame 10.7 **582908000**
Bühnenprofil 1,00m für Abstützbock



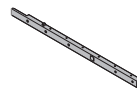







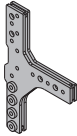

Galvanised
Length: 147.5 cm

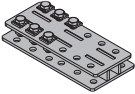

Extension safety clamp for platform profile 1.7 **582909000**
Auszugsicherung für Bühnenprofil

Galvanised
Length: 38.4 cm

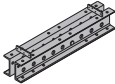

	[kg]	Article n°		[kg]	Article n°
Handrail post 1.00m Geländer 1,00m	3.8	584335000	 Galvanised Length: 124 cm	Heavy-duty wheel 90kN Schwerlastrad 90kN	85.0 582921000  Galvanised Height: 38 cm
T plate for supporting construction frame T-Lasche für Abstützbock	29.8	582910000	 Painted blue Length: 74.6 cm	Wheel connector F 2.40m Radanschluss F 2,40m	45.0 582922000  Galvanised Length: 49 cm Width: 36 cm Height: 25 cm
Connecting pin SL-1 D32 100 Verbindungsbolzen SL-1 D32 100	1.0	582885000	 Galvanised Length: 17 cm	Travelling profile bracket F 2.40m Verfahrprofil-Konsole F 2,40m	31.0 582924000  Galvanised Length: 28.5 cm Width: 22 cm Height: 48.2 cm
Handrail post T 1.80m Einschubgeländer T 1,80m	17.7	584373000	 Galvanised		
Toeboard holder T 1.80m Fußwehrhalter T 1,80m	0.53	584392000	 Galvanised Height: 13.5 cm		
Intermediate flange for supp. constr. frame Zwischenflansch für Abstützbock	16.2	582911000	 Painted blue Length: 42.7 cm		
Pressure shoe T7/T16 Druckschuh T7/T16	18.5	582913000	 Painted blue Height: 72.5 cm		
Multi-purpose waling SL-1 WU16 1.00m Multi-purpose waling SL-1 WU16 3.00m Mehrzweckriegel SL-1	35.0 107.0	582877000 582888000	 Painted blue		
Waling connector SL-1 WU16 0.75m Riegelverbinder SL-1 WU16 0,75m	31.0	582886000	 Galvanised Length: 75 cm		