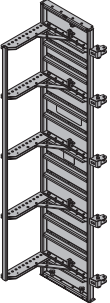
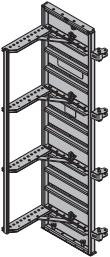
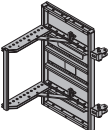
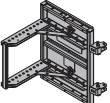
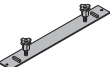

	[kg]	Article n°
Xlife panel KS 3.30m Xlife-Element KS 3,30m	185.0	580346500
 <p>Galvanised Width: 80 cm Delivery condition: folded closed</p>		

Xlife panel KS 2.70m Xlife-Element KS 2,70m	140.0	580337500
 <p>Galvanised Width: 80 cm Delivery condition: folded closed</p>		

Xlife panel KS 1.20m Xlife-Element KS 1,20m	66.0	580338500
 <p>Galvanised Width: 80 cm Delivery condition: folded closed</p>		

Xlife panel KS 0.90m Xlife-Element KS 0,90m	56.0	580339500
 <p>Galvanised Width: 80 cm Delivery condition: folded closed</p>		

Protective plate KS Schutzleiste KS	3.3	580343000
 <p>Galvanised Length: 70 cm Width: 9 cm</p>		

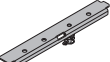
Protective plate KS top Schutzleiste KS oben	3.0	580357000
 <p>Galvanised Length: 65.3 cm Width: 8.4 cm</p>		

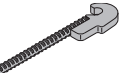
Locking hook KS Verschlussshaken KS	0.83	580344000
 <p>Galvanised Length: 31 cm</p>		

Super plate 15.0 Superplatte 15,0	1.1	581966000
 <p>Galvanised Height: 6 cm Diameter: 12 cm Width-across: 27 mm</p>		

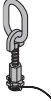

	[kg]	Article n°
Lifting ring Umsetzring	1.4	580340000
 <p>Galvanised Height: 20 cm</p>		

Stacking screw KS Aufstockschraube KS	0.77	580345000
 <p>Galvanised Height: 20 cm</p>		

Frontal triangular ledge KS 20 4.00m Stimdreikanteleiste KS 15 4.00m	0.93	580347000
 <p>Grey</p>	0.71	580359000

Framax triangular ledge 2.70m Framax-Dreikanteleiste 2,70m	0.38	588170000
		

Panel strut 340 IB Elementstütze 340 IB	24.3	580365000
consisting of:		

(A) Plumbing strut 340 IB Galvanised Length: 190.8 - 341.8 cm	16.7	588696000
--	------	------------------

(B) Adjusting strut 120 IB Galvanised Length: 81.5 - 130.6 cm	7.6	588248500
--	-----	------------------

Galvanised
Delivery condition: folded closed

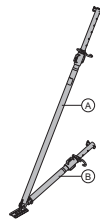

Panel strut 540 IB Elementstütze 540 IB	41.4	580366000
consisting of:		

(A) Plumbing strut 540 IB Galvanised Length: 310.5 - 549.2 cm	30.7	588697000
--	------	------------------

(B) Adjusting strut 220 IB Galvanised Length: 172.5 - 221.1 cm	10.9	588251500
---	------	------------------

Galvanised
Delivery condition: folded closed

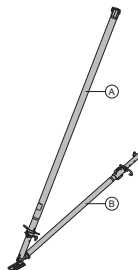



Prop head KS EB Stützenkopf KS EB	0.85	580342000
---	------	------------------

Galvanised
Length: 14 cm
Width: 11 cm
Height: 14 cm

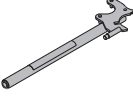

	[kg]	Article n°
Universal dismantling tool Universal-Lösewerkzeug	3.7	582768000
 Galvanised Length: 75.5 cm		

Doka express anchor 16x125mm Doka-Expressanker 16x125mm	0.31	588631000
 Galvanised Length: 18 cm Follow fitting instructions!		

Doka coil 16mm Doka-Coil 16mm	0.009	588633000
 Galvanised Diameter: 1.6 cm		

Gauge for Doka express anchor 16x125mm Lehre Doka-Expressanker 16x125mm	0.03	588632000
 Black Length: 3 cm Diameter: 2 cm		

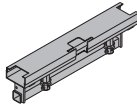
Platform adapter KS Bühnenanschluss KS	11.4	580341000
 Galvanised Length: 74 cm Width: 12 cm Height: 20 cm		

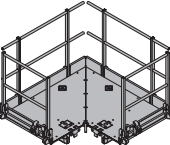
Doka column formwork platform 150/90cm Doka-Stützenbühne 150/90cm	211.8	588382000
 Galvanised Length: 173 cm Width: 173 cm Height: 130 cm Delivery condition: folded closed		

Counter railing col. formwork plat. 150/90cm Gegengeländer Stützenbühne 150/90cm	8.0	588385000
 Galvanised Width: 87 cm Height: 170 cm		

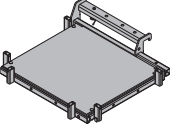
Platform planking KS Fertigbelag KS	32.3	580360000
 Timber parts varnished yellow Steel parts galvanised Length: 90 cm Width: 85 cm		

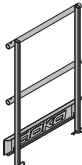
Railing KS 1.00x0.85m Fertiggeländer KS 1,00x0,85m	12.4	580363000
 Galvanised		

	[kg]	Article n°
Counter railing platform planking KS Gegengeländer Fertigbelag KS	7.4	580361000
 Galvanised Width: 91.6 cm Height: 170 cm		

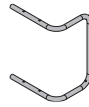
Side railing KS 0.30m Seitengeländer KS 0,30m	2.6	580364000
 Galvanised Length: 38 cm Width: 30 cm Height: 53 cm		

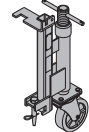
Shifting wheel KS Umsetzrad KS	15.8	580358000
 Galvanised Follow the directions in the "Operating Instructions!"		CE

Doka 4-part chain 3.20m Doka-Vierstrangkette 3,20m	15.0	588620000
 Follow the directions in the "Operating Instructions!"		CE

Connecting pin 10cm Verbindungsbolzen 10cm	0.34	580201000
 Galvanised Length: 14 cm		