

	[kg]	Article n°
Formwork element FF20 2.00x2.75m 21mm	335.0	587512000
Formwork element FF20 1.00x2.75m 21mm	166.0	587508000
Formwork element FF20 0.75x2.75m 21mm	131.0	587504000
Formwork element FF20 0.50x2.75m 21mm	92.0	587500000
Formwork element FF20 2.00x1.00m 21mm	190.0	587523000
Formwork element FF20 1.00x1.00m 21mm	95.0	587522000
Formwork element FF20 0.75x1.00m 21mm	79.5	587521000
Formwork element FF20 0.50x1.00m 21mm	58.0	587520000
Formwork element FF20 2.00x3.75m 21mm	440.0	587564000
Formwork element FF20 1.00x3.75m 21mm	224.0	587562000
Formwork element FF20 0.75x3.75m 21mm	172.0	587561000
Formwork element FF20 0.50x3.75m 21mm	120.0	587560000
Formwork element FF20 2.00x6.50m 21mm	692.0	587563000
Formwork element FF20 1.00x6.50m 21mm	346.0	587565000
Formwork element FF20 0.75x6.50m 21mm	272.0	587566000
Formwork element FF20 0.50x6.50m 21mm	189.5	587567000
Fertigelement FF20 21mm		

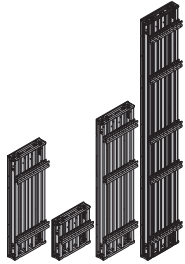

Formwork element FF20 2.00x2.75m 27mm	348.0	587606000
Formwork element FF20 1.00x2.75m 27mm	173.0	587604000
Formwork element FF20 0.75x2.75m 27mm	136.0	587602000
Formwork element FF20 0.50x2.75m 27mm	96.0	587600000
Formwork element FF20 2.00x1.00m 27mm	195.0	587616000
Formwork element FF20 1.00x1.00m 27mm	103.0	587614000
Formwork element FF20 0.75x1.00m 27mm	81.5	587612000
Formwork element FF20 0.50x1.00m 27mm	59.5	587610000
Fertigelement FF20 27mm		

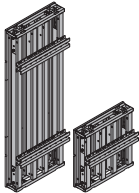

Stacking element FF20 2.00x0.50m 21mm	90.5	587529000
Stacking element FF20 1.00x0.50m 21mm	45.4	587528000
Stacking element FF20 0.75x0.50m 21mm	36.4	587527000
Stacking element FF20 0.50x0.50m 21mm	27.5	587526000
Aufstockelement FF20 21mm		



Stacking element FF20 2.00x0.50m 27mm	67.5	587626000
Stacking element FF20 1.00x0.50m 27mm	33.4	587624000
Stacking element FF20 0.75x0.50m 27mm	28.8	587622000
Stacking element FF20 0.50x0.50m 27mm	21.0	587620000
Aufstockelement FF20 27mm		



Inside corner FF20 2.75m 21mm	214.0	587516000
Inside corner FF20 1.00m 21mm	117.0	587525000
Innenecke FF20 21mm		

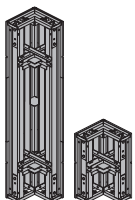

Inside corner FF20 2.75m 27mm	220.0	587608000
Inside corner FF20 1.00m 27mm	120.0	587618000
Inside corner FF20 0.50m 27mm	33.5	587628000
Innenecke FF20 27mm		

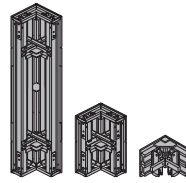

Swivelling inside corner FF20 2.75m 21mm	246.5	587577000
Swivelling inside corner FF20 1.00m 21mm	103.0	587575000
Swivelling inside corner FF20 0.50m 21mm	53.7	587573000
Gelenkinnenecke FF20 21mm		

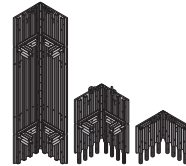

Swivelling inside corner FF20 0.50m 27mm	55.0	587647000
Swivelling inside corner FF20 1.00m 27mm	108.8	587649000
Swivelling inside corner FF20 2.75m 27mm	255.0	587651000
Gelenkinnenecke FF20 27mm		

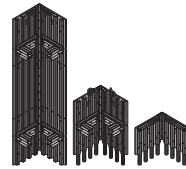

Swivelling outside corner FF20 2.75m 21mm	102.7	587579000
Swivelling outside corner FF20 1.00m 21mm	46.2	587578000
Gelenkaußenecke FF20 21mm		

Painted blue

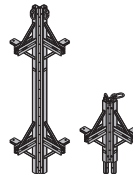

Swivelling outside corner FF20 2.75m 27mm	102.7	587654000
Swivelling outside corner FF20 1.00m 27mm	46.2	587653000
Gelenkaußenecke FF20 27mm		

Painted blue

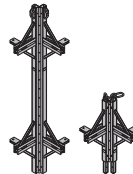

Swivelling outside corner FF20 0.50m	16.1	587652000
Gelenkaußenecke FF20 0,50m		

Painted blue



Corner plate FF20 G	7.2	587571000
Ecklasche FF20 G		

Painted blue
Length: 49 cm
Width: 24 cm

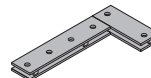

	[kg]	Article n°
Fastening bolt FF20 Spannbolzen FF20	0.30	587545000
	Galvanised Length: 17 cm Width-across: 30 mm	

Star grip nut 15.0 G Sternmutter 15,0 G	0.47	587544000
	Galvanised Width: 10 cm Height: 5 cm Width-across: 30 mm	

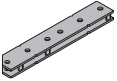
Formwork element connector FF20/50 Z Elementverbinder FF20/50 Z	6.0	587533000
	Painted blue Length: 55 cm	

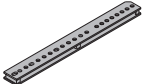
Adjustable waling extension FF20/50 Ausgleichslasche FF20/50	9.1	587532000
	Painted blue Length: 87 cm	

Beam clamp Top50 Trägerklammer Top50	1.2	580081000
	Painted blue Height: 15 cm	

Anchoring plate FF20/50 Ankerungslasche FF20/50	6.6	587531000
	Painted blue Length: 55 cm	

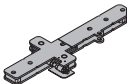
Splice plate with join adjustment Verbindungslasche mit Fugenjustierung	13.8	580215000
	Painted blue Length: 76 cm	

Distribution plate FF20 Verteilerplatte FF20	1.7	580216000
	Galvanised Width: 10.9 cm Height: 12 cm	

Offset plate FF20 Versatzlasche FF20	6.2	587534000
	Painted blue Length: 35 cm Width: 18 cm Height: 4 cm	

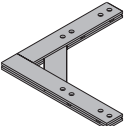
Outside angle plate FF20 21mm	18.6	587535000
Outside angle plate FF20 27mm	18.6	587634000
Außennecklasche FF20	Painted blue Leg length: 60 cm	
		

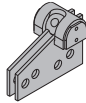
	[kg]	Article n°
Universal angle tie bracket Universal-Winkelspanner	4.4	580604000
	Painted blue Length: 20 cm	

Connecting pin 10cm Verbindungsbolzen 10cm	0.34	580201000
	Galvanised Length: 14 cm	

Spring cotter 5mm Federvorstecker 5mm	0.05	580204000
	Galvanised Length: 13 cm	

Flange clamp H20 Flanschklammer H20	1.0	580135000
	Galvanised Width: 13 cm Width-across: 19 mm	

Stacking angle FF20 Aufstockwinkel FF20	7.8	587547000
	Painted blue Height: 46 cm	

Multi-purpose waling WS10 Top50 0.50m	10.2	580001000
Multi-purpose waling WS10 Top50 0.75m	14.9	580002000
Multi-purpose waling WS10 Top50 1.00m	19.6	580003000
Multi-purpose waling WS10 Top50 1.25m	24.7	580004000
Multi-purpose waling WS10 Top50 1.50m	29.7	580005000
Multi-purpose waling WS10 Top50 1.75m	35.0	580006000
Multi-purpose waling WS10 Top50 2.00m	38.9	580007000
Multi-purpose waling WS10 Top50 2.25m	44.2	580008000
Multi-purpose waling WS10 Top50 2.50m	48.7	580009000
Multi-purpose waling WS10 Top50 2.75m	54.2	580010000
Multi-purpose waling WS10 Top50 3.00m	58.9	580011000
Multi-purpose waling WS10 Top50 3.50m	68.4	580012000
Multi-purpose waling WS10 Top50 4.00m	79.4	580013000
Multi-purpose waling WS10 Top50 4.50m	89.1	580014000
Multi-purpose waling WS10 Top50 5.00m	102.0	580015000
Multi-purpose waling WS10 Top50 5.50m	112.4	580016000
Multi-purpose waling WS10 Top50 6.00m	118.0	580017000
Mehrzweckriegel WS10 Top50		

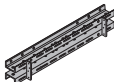
	Painted blue	
---	--------------	--

Box-out clamp 24cm	3.3	580063000
Box-out clamp 25cm	3.4	580064000
Box-out clamp 30cm	3.8	580065000
Aussparungsklemme		

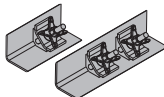
	Galvanised Leg length: 10 cm	
---	---------------------------------	--

Box-out clamp type 1cm	20.0	580066000
Box-out clamp type 2cm	17.4	580067000
Aussparungsklemmecm		

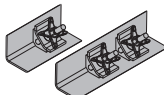
	Painted blue Leg length: 10 cm	
---	-----------------------------------	--

	[kg]	Article n°
Wall-formwork support angle Auflagewinkel Wandschalung	6.6	588967000
 Galvanised Length: 15.8 cm Width: 12 cm Height: 11.2 cm		

Panel strut 340 IB Elementstütze 340 IB	24.3	580365000
consisting of:		
(A) Plumbing strut 340 IB Galvanised Length: 190.8 - 341.8 cm	16.7	588696000
(B) Adjusting strut 120 IB Galvanised Length: 81.5 - 130.6 cm	7.6	588248500

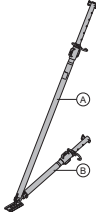
 Galvanised Delivery condition: folded closed		
--	--	--

Panel strut 540 IB Elementstütze 540 IB	41.4	580366000
consisting of:		
(A) Plumbing strut 540 IB Galvanised Length: 310.5 - 549.2 cm	30.7	588697000
(B) Adjusting strut 220 IB Galvanised Length: 172.5 - 221.1 cm	10.9	588251500

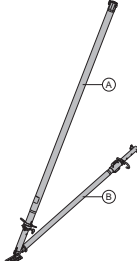
 Galvanised Delivery condition: folded closed		
---	--	--

	[kg]	Article n°
Eurex 60 550 Eurex 60 550		
depending on length, comprising:		
(A) Plumbing strut Eurex 60 550	42.5	582658000
Powder-coated, blue Aluminium Length: 343 - 553 cm		
(B) Extension Eurex 60 2.00m	21.3	582651000
Powder-coated, blue Aluminium Length: 250 cm		
(C) Coupler Eurex 60	8.6	582652000
Aluminium Length: 100 cm Diameter: 12.8 cm		
(D) Connector Eurex 60 IB	4.2	582657500
Galvanised Length: 15 cm Width: 15 cm Height: 30 cm		
(E) Plumbing strut shoe Eurex 60 EB	8.0	582660500
Galvanised Length: 31 cm Width: 12 cm Height: 33 cm		
(F) Adjusting strut 540 Eurex 60 IB	27.8	582659500
Galvanised Length: 303.5 - 542.2 cm		

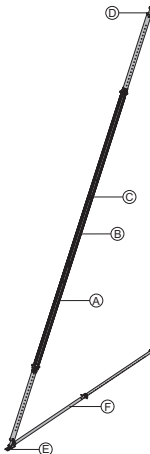
 Delivery condition: separate parts		
---	--	--

Prop head EB Stützenkopf EB	3.1	588244500
 Galvanised Length: 40.8 cm Width: 11.8 cm Height: 17.6 cm		

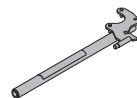
Universal dismantling tool Universal-Lösewerkzeug	3.7	582768000
 Galvanised Length: 75.5 cm		

Doka express anchor 16x125mm Doka-Expressanker 16x125mm	0.31	588631000
 Galvanised Length: 18 cm Follow fitting instructions!		

Doka coil 16mm Doka-Coil 16mm	0.009	588633000
 Galvanised Diameter: 1.6 cm		

	[kg]	Article n°
Gauge for Doka express anchor 16x125mm Lehre Doka-Expressanker 16x125mm	0.03	588632000
 Black Length: 3 cm Diameter: 2 cm		

Top scaffold bracket L Betontierkonsole L	12.6	587153500
 Galvanised Length: 101 cm Height: 159 cm		

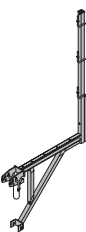
Universal bracket 90 Universal-Konsole 90	30.4	580476000
 Galvanised Length: 121 cm Height: 235 cm		

Universal corner bracket 90 right Universal corner bracket 90 left Universa-Eckkonsole 90	29.5 29.5	580071000 580070000
 Galvanised Length: 152 cm Height: 235 cm		

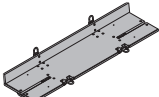
Bracket planking 60/250cm Bracket planking 90/250cm Konsolenbelag	48.5 61.3	583029000 583031000
 Steel parts galvanised Timber parts varnished yellow		

Bracket railing 240-270cm Konsolengeländer 240-270cm	22.5	583032000
 Galvanised		

Universal railing shackle Universal-Geländerbügel	3.0	580478000
 Galvanised Height: 20 cm		

	[kg]	Article n°
Scaffold tube 48.3mm 0.50m	1.7	682026000
Scaffold tube 48.3mm 1.00m	3.6	682014000
Scaffold tube 48.3mm 1.50m	5.4	682015000
Scaffold tube 48.3mm 2.00m	7.2	682016000
Scaffold tube 48.3mm 2.50m	9.0	682017000
Scaffold tube 48.3mm 3.00m	10.8	682018000
Scaffold tube 48.3mm 3.50m	12.6	682019000
Scaffold tube 48.3mm 4.00m	14.4	682021000
Scaffold tube 48.3mm 4.50m	16.2	682022000
Scaffold tube 48.3mm 5.00m	18.0	682023000
Scaffold tube 48.3mm 5.50m	19.8	682024000
Scaffold tube 48.3mm 6.00m	21.6	682025000
Scaffold tube 48.3mmm Gerüstrohr 48,3mm	3.6	682001000

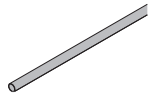
 Galvanised Height: 7 cm		
--	--	--

Scaffold tube connection Gerüstrohranschluss	0.27	584375000
 Galvanised Height: 7 cm		

Screw-on coupler 48mm 50 Anschraubkupplung 48mm 50	0.84	682002000
 Galvanised Width-across: 22 mm Follow fitting instructions!		

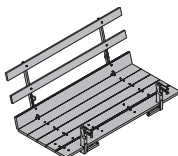
Framax pouring platform U 1.25/2.70m Framax-Betontierbühne U 1,25/2,70m	127.5	588377000
 Steel parts galvanised Timber parts varnished yellow Delivery condition: folded closed		

FF20 adapter for Framax pouring platform U FF20-Adapter für Framax-Betontierbühne U	6.8	588381000
 Galvanised Length: 34 cm		

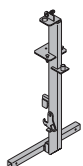
Top50 adapter for Framax pouring platform U Top50-Adapter für Framax-Betontierbühne U	18.5	588384000
 Galvanised Width: 75 cm Height: 134 cm		

Handrail post XP 1.20m Geländersteher XP 1,20m	4.1	586460000
 Galvanised Height: 118 cm		

Toeboard holder XP 1.20m Fußwehrhalter XP 1,20m	0.64	586461000
 Galvanised Height: 21 cm		

	[kg]	Article n°
Railing clamp XP 40cm Geländerzwinge XP 40cm	7.7	586456000
 Galvanised Height: 73 cm		

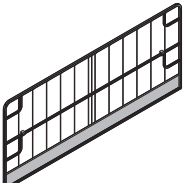
Protective grating XP 2.70x1.20m	22.2	586450000
Protective grating XP 2.50x1.20m	20.5	586451000
Protective grating XP 2.00x1.20m	17.4	586452000
Protective grating XP 1.20x1.20m	12.0	586453000
Schutzgitter XP		
 Galvanised		

Velcro fastener 30x380mm Klettverschluss 30x380mm	0.02	586470000
 Yellow		

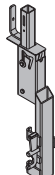
Timber-beam formwork adapter XP Trägerschalungsadapter XP	9.5	586476000
 Galvanised Height: 83.5 cm		

Handrail clamp S Schutzgeländerzwinge S	11.5	580470000
 Galvanised Height: 123 - 171 cm		

Handrail post 1.10m Schutzgeländer 1,10m	5.5	584384000
 Galvanised Height: 134 cm		

Attachable sleeve 24mm Steckhülse 24mm	0.03	584385000
 Grey Length: 16.5 cm Diameter: 2.7 cm		

Screw sleeve 20.0 Schraubhülse 20,0	0.03	584386000
 Yellow Length: 20 cm Diameter: 3.1 cm		

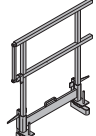
	[kg]	Article n°
Side handrail clamping unit T Seitenschutzgeländer T	29.1	580488000
 Galvanised Length: 115 - 175 cm Height: 112 cm		

Handrail post T 1.80m Einschubgeländer T 1,80m	17.7	584373000
 Galvanised		

Toeboard holder T 1.80m Fußwehrhalter T 1,80m	0.53	584392000
 Galvanised Height: 13.5 cm		

Doka 4-part chain 3.20m Doka-Vierstrangkette 3,20m	15.0	588620000
 Follow the directions in the "Operating Instructions!"		CE

Lifting chain 100cm 15kN Anschlagkette 100cm 15kN	1.8	587548000
 Length: 103 cm Follow the directions in the "Operating Instructions!"		CE

Dokamatic lifting strap 13.00m Dokamatic-Umsetzgurt 13,00m	10.5	586231000
 Green Follow the directions in the "Operating Instructions!"		CE

Lifting bracket Kranöse	6.2	580460000
 Galvanised Height: 59 cm		

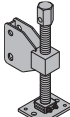
Height adjuster WS10-WU16 Höhenjustierung WS10-WU16	10.1	580206500
 Galvanised Height: 45 cm		

Tie-off connector type A Anhängewinkel Typ A	0.96	581641000
 Galvanised Length: 13.7 cm		

[kg] Article n°

[kg] Article n°

Doka personal fall-arrest set
Doka-Auffanggurt

3.6 **583022000**



Follow the directions in the
"Operating Instructions"!

