

	[kg]	Article n°
Staxo 40 frame 0.90m	14.6	582202000
Staxo 40 frame 1.20m	17.5	582201000
Staxo 40 frame 1.80m	24.5	582200000
Staxo 40-Rahmen		

Galvanised

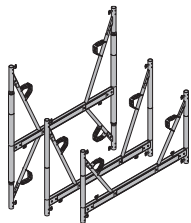

Staxo 40 coupler	0.60	582203000
Staxo 40-Kupplungsstück		

Galvanised
Height: 30.8 cm



Staxo 40 tube connector D48.3mm	0.07	582204000
Staxo 40-Rohrstecker D48,3mm		

Yellow



Diagonal cross 9.100	4.1	582772000
Diagonal cross 9.150	5.2	582773000
Diagonal cross 9.175	6.1	582334000
Diagonal cross 9.200	6.6	582774000
Diagonal cross 9.250	7.7	582775000
Diagonal cross 9.300	9.0	582323000
Diagonal cross 12.100	4.6	582610000
Diagonal cross 12.150	5.7	582612000
Diagonal cross 12.175	6.3	582335000
Diagonal cross 12.200	6.9	582614000
Diagonal cross 12.250	8.3	582616000
Diagonal cross 12.300	9.3	582325000
Diagonal cross 18.100	6.1	582620000
Diagonal cross 18.150	6.9	582622000
Diagonal cross 18.175	7.8	582336000
Diagonal cross 18.200	7.8	582624000
Diagonal cross 18.250	9.1	582626000
Diagonal cross 18.300	10.3	582326000
Diagonalkreuz		

Galvanised
Delivery condition: folded closed



Staxo 40 4-way screw-jack head 30cm	6.5	582209000
Staxo 40-Vierwegkopfspindel 30cm		

Galvanised
Height: 67.8 cm



Staxo 40 4-way screw-jack head 70cm	8.9	582210000
Staxo 40-Vierwegkopfspindel 70cm		

Galvanised
Height: 117.6 cm



Staxo 40 screw jack U-head 30cm	4.7	582207000
Staxo 40-Kopfspindel 30cm		

Galvanised
Height: 55.7 cm



Staxo 40 screw jack U-head 70cm	7.0	582208000
Staxo 40-Kopfspindel 70cm		

Galvanised
Height: 105.5 cm



Lowering head H20	6.1	586174000
Absenkkopf H20		

Galvanised
Length: 25 cm
Width: 20 cm
Height: 38 cm

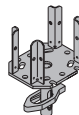

4-way head H20	4.0	586170000
Vierwegkopf H20		

Galvanised
Length: 25 cm
Width: 20 cm
Height: 33 cm

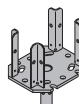

Doka Xtra head	9.7	586108000
Doka Xtra-Kopf		

Galvanised
Height: 69 cm



Clamping plate D	2.0	502709030
Klemmplatte D		

Galvanised
Length: 24 cm
Width: 9 cm



Wing nut 15.0	0.31	581961000
Flügelmutter 15,0		

Galvanised
Length: 10 cm
Height: 5 cm
Width-across: 27 mm



DIN
18216

Locking rod 15.0 330mm	0.48	582641000
Quetschteil 15,0 330mm		

Galvanised
Width-across: 24 mm



Staxo 40 4-way screw-jack head 30cm	6.5	582209000
Staxo 40-Vierwegkopfspindel 30cm		

Galvanised
Height: 67.8 cm



Dokamatic table Staxo spindle connector	3.9	582347000
Staxo-Spindelanschluss Dokamatic-Tisch		

Galvanised
Length: 20.7 cm



Wedge for screw jack %	0.46	176071000
Spindelkeil %		

Length: 20 cm
Width: 16 cm



Staxo 40 spindle adapter	2.1	582240000
Staxo 40-Spindeladapter		

Galvanised
Height: 26 cm





Super plate 15.0	1.1	581966000
Superplatte 15,0		

Galvanised
Height: 6 cm
Diameter: 12 cm
Width-across: 27 mm





DIN
18216

	[kg]	Article n°
Staxo wedge support WS10 Staxo-Keilauflager WS10	8.7	582796000
 Galvanised Length: 31 cm Width: 15 cm Height: 23 cm		

Staxo wedge support WU12/14 Staxo-Keilauflager WU12/14	12.2	582350000
 Galvanised Length: 35.6 cm Width: 15 cm Height: 33.6 cm		

Swivel bearing plate for screw jack U-head Gelenkaufsatz Kopfspindel	5.2	582799000
 Galvanised Length: 20.8 cm Width: 15.0 cm Height: 14.4 cm		

Staxo 40 screw jack foot 30cm Staxo 40-Fußspindel 30cm	3.9	582205000
 Galvanised Height: 50.7 cm		

Staxo 40 screw jack foot 70cm Staxo 40-Fußspindel 70cm	6.1	582206000
 Galvanised Height: 100.5 cm		

Staxo 40 anti-dropout lock Staxo 40-Spindelsicherung	0.54	582211000
 Galvanised Powder-coated, blue Length: 9.0 cm Width: 8.8 cm Height: 8.6 cm		

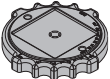
Compensating plate Ausgleichsplatte	1.2	582239000
 Orange Black Diameter: 30 cm		

Plumbing strut Eurex 60 550 Justierstütze Eurex 60 550	42.5	582658000
 Powder-coated, blue Aluminium Length: 343 - 553 cm		

	[kg]	Article n°
Extension Eurex 60 2.00m Verlängerung Eurex 60 2,00m	21.3	582651000
 Powder-coated, blue Aluminium Length: 250 cm		

Coupler Eurex 60 Kupplungsstück Eurex 60	8.6	582652000
 Aluminium Length: 100 cm Diameter: 12.8 cm		

Prop head Eurex 60 Top50 Stützenkopf Eurex 60 Top50	7.1	582665000
 Galvanised Height: 50 cm		

Connector Eurex 60 IB Verbindungsstück Eurex 60 IB	4.2	582657500
 Galvanised Length: 15 cm Width: 15 cm Height: 30 cm		

Plumbing strut shoe Eurex 60 EB Justierstützenfuß Eurex 60 EB	8.0	582660500
 Galvanised Length: 31 cm Width: 12 cm Height: 33 cm		

Plumbing strut 340 IB Justierstütze 340 IB	16.7	588696000
 Galvanised Length: 190.8 - 341.8 cm		

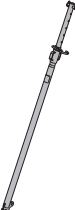
Plumbing strut 340 IB EF Justierstütze 340 IB EF	14.9	588247500
 Galvanised Length: 190.8 - 341.8 cm		

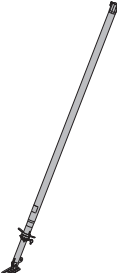
Plumbing strut 540 IB Justierstütze 540 IB	30.7	588697000
 Galvanised Length: 310.5 - 549.2 cm		

	[kg]	Article n°
Plumbing strut 540 IB EF Justierstütze 540 IB EF	28.9	588250500
 Galvanised Length: 310.5 - 549.2 cm		

Strut shoe EB Strebenschuh EB	0.93	588946000
 Galvanised Width: 8 cm Height: 13 cm		

Prop shoe EB Stützenschuh EB	1.8	588245500
 Galvanised Length: 20 cm Width: 11 cm Height: 10 cm		

Staxo 40 plumbing strut adapter EB Staxo 40-Justierstützenadapter EB	1.1	582214500
 Galvanised Height: 16 cm		

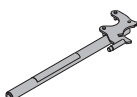
Universal dismantling tool Universal-Lösewerkzeug	3.7	582768000
 Galvanised Length: 75.5 cm		

Doka express anchor 16x125mm Doka-Expressanker 16x125mm	0.31	588631000
 Galvanised Length: 18 cm Follow fitting instructions!		

Doka coil 16mm Doka-Coil 16mm	0.009	588633000
 Galvanised Diameter: 1.6 cm		

Gauge for Doka express anchor 16x125mm Lehre Doka-Expressanker 16x125mm	0.03	588632000
 Black Length: 3 cm Diameter: 2 cm		

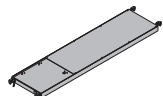
Scaffold planking 60/100cm with manhole	9.5	582311500
Scaffold planking 60/150cm with manhole	13.8	582312500
Scaffold planking 60/175cm with manhole	15.5	582333500
Scaffold planking 60/200cm with manhole	17.7	582313500
Scaffold planking 60/250cm with manhole	20.8	582314500
Scaffold planking 60/300cm with manhole Gerüstbelag mit Durchstieg	26.3	582315500
 Aluminium		

	[kg]	Article n°
Scaffold planking 30/100cm	7.4	582231000
Scaffold planking 30/150cm	10.6	582232000
Scaffold planking 30/200cm	13.5	582234000
Scaffold planking 30/250cm	16.4	582235000
Scaffold planking 30/300cm Gerüstbelag	19.5	582236000
 Galvanised		

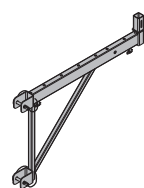
Staxo 40 bracket 90cm Staxo 40-Konsole 90cm	8.6	582212000
 Galvanised Width: 108.9 cm Height: 65.5 cm		

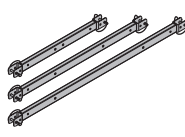
Staxo 40 planking strut 1.00m	5.7	582215000
Staxo 40 planking strut 1.50m	7.3	582216000
Staxo 40 planking strut 2.00m Staxo 40-Belagstrebe	9.3	582217000
 Galvanised		

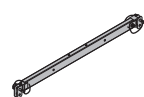
Staxo 40 frame strut 1.40m Staxo 40-Rahmenstrebe 1,40m	6.5	582213000
 Galvanised		

Staxo front railing Staxo-Stirngeländer	10.5	582316000
 Galvanised Length: 140 cm Height: 152 cm		

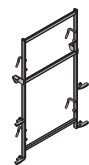
Staxo side railing 100	17.5	582317500
Staxo side railing 150	20.0	582318500
Staxo side railing 175	23.2	582331500
Staxo side railing 200	24.1	582319500
Staxo side railing 250	27.5	582320500
Staxo side railing 300 Staxo-Seitengeländer	31.1	582321500
 Galvanised Height: 152 cm		

Spring locked connecting pin 16mm Federbolzen 16mm	0.25	582528000
 Galvanised Length: 15 cm		

	[kg]	Article n°
Staxo 40/d3 ladder 2.30m Staxo 40/d3-Leiter 2,30m	15.5	582219500
 Galvanised		

Scaffold tube 48.3mm 0.50m	1.7	682026000
Scaffold tube 48.3mm 1.00m	3.6	682014000
Scaffold tube 48.3mm 1.50m	5.4	682015000
Scaffold tube 48.3mm 2.00m	7.2	682016000
Scaffold tube 48.3mm 2.50m	9.0	682017000
Scaffold tube 48.3mm 3.00m	10.8	682018000
Scaffold tube 48.3mm 3.50m	12.6	682019000
Scaffold tube 48.3mm 4.00m	14.4	682021000
Scaffold tube 48.3mm 4.50m	16.2	682022000
Scaffold tube 48.3mm 5.00m	18.0	682023000
Scaffold tube 48.3mm 5.50m	19.8	682024000
Scaffold tube 48.3mm 6.00m	21.6	682025000
Scaffold tube 48.3mmm Gerüstrohr 48,3mm	3.6	682001000

 Galvanised		
---	--	--

Swivel coupler 48mm Drehkupplung 48mm	1.5	582560000
 Galvanised Width-across: 22 mm Follow fitting instructions!		

Normal coupler 48mm Normalkupplung 48mm	1.2	682004000
 Galvanised Width-across: 22 mm Follow fitting instructions!		

Screw-on coupler 48mm 50 Anschraubkupplung 48mm 50	0.84	682002000
 Galvanised Width-across: 22 mm Follow fitting instructions!		

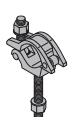
Screw-on coupler 48mm 95 Anschraubkupplung 48mm 95	0.88	586013000
 Galvanised Follow fitting instructions!		

Anchoring shoe for stair tower Ankerschuh für Treppenturm	3.4	582680000
 Galvanised Length: 22 cm Width: 12 cm Height: 22 cm		

Cone screw B 7cm Konusschraube B 7cm	0.86	581444000
 red Length: 10 cm Diameter: 7 cm Width-across: 50 mm		

	[kg]	Article n°
Handrail post XP 1.20m Geländersteher XP 1,20m	4.1	586460000
 Galvanised Height: 118 cm		

Toeboard holder XP 1.20m Fußwehrhalter XP 1,20m	0.64	586461000
 Galvanised Height: 21 cm		

Beam connection plate H20 Gurtverbinder H20	0.08	586263000
 Galvanised Height: 8 cm		

Bracing for load-bearing towers Abspannung für Traggerüste	11.6	582795000
 Galvanised Painted blue		

Spindle connecting plate T Spindellasche T	3.1	584371000
 Galvanised Width: 20 cm Height: 25 cm		

Connecting pin 10cm Verbindungsbolzen 10cm	0.34	580201000
 Galvanised Length: 14 cm		

Spring cotter 5mm Federvorstecker 5mm	0.05	580204000
 Galvanised Length: 13 cm		

Secondary-beam stabiliser 1 Secondary-beam stabiliser 2 Querträgersicherung	1.6 2.1	586196000 586197000
 Galvanised Height: 38.7 cm		

Lifting rod 15.0 Umsetzstab 15,0	1.9	586074000
 Blue Height: 57 cm Follow the directions in the "Operating Instructions"!		CE

Retaining plate 15.0 Jochplatte 15,0	1.8	586073000
 Galvanised Length: 17 cm Width: 12 cm Height: 11 cm		

Universal plug R20/25 0.003 **588180000**

Kombi-Ankerstopfen R20/25



Blue
Diameter: 3 cm

Staxo 40 shifting wheel 22.8 **582218000**

Staxo 40-Umsetzrad

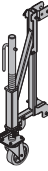

Galvanised
Height: 120 cm
Follow the directions in the
"Operating Instructions"!

CE

Fork lift shifting device TG 83.0 **582797000**

Umsetzgerät TG für Stapler

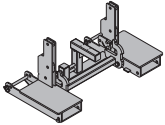

Galvanised
Length: 60 cm
Width: 113 cm
Height: 52 cm
Follow the directions in the
"Operating Instructions"!

CE

Staxo 40 lifting strut 9.5 **582224000**

Staxo 40-Umsetzstrebe

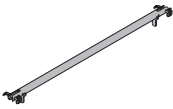

Galvanised
Length: 144 cm

Multi-purpose waling WS10 Top50 2.00m 38.9 **580007000**

Mehrweckriegel WS10 Top50 2,00m

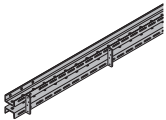

Painted blue

Doka personal fall-arrest set 3.6 **583022000**

Doka-Auffanggurt



Follow the directions in the
"Operating Instructions"!

CE