







	[kg]	Article n°
Doka folding platform K 3.00m	291.5	580442000
Doka folding platform K 4.50m	444.5	580443000
Doka-Faltbühne K		
		
Timber parts varnished yellow		
Steel parts galvanised		
Delivery condition: folded closed		

Folding bracket K	52.4	580441000
Faltkonsole K		
		
Galvanised		
Length: 224 cm		
Height: 245 cm		
Delivery condition: folded closed		

Connection-shoe K	6.4	580451000
Anschluss Schuh K		
		
Galvanised		
Length: 25 cm		
Width: 17 cm		

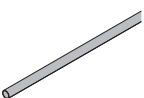
Suspended platform 120 3.30m	44.0	580411000
Suspended platform 120 4.30m	52.6	580412000
Hängebühne 120		
		
Galvanised		
Delivery condition: folded closed		

Scaffold tube 48.3mm 0.50m	1.7	682026000
Scaffold tube 48.3mm 1.00m	3.6	682014000
Scaffold tube 48.3mm 1.50m	5.4	682015000
Scaffold tube 48.3mm 2.00m	7.2	682016000
Scaffold tube 48.3mm 2.50m	9.0	682017000
Scaffold tube 48.3mm 3.00m	10.8	682018000
Scaffold tube 48.3mm 3.50m	12.6	682019000
Scaffold tube 48.3mm 4.00m	14.4	682021000
Scaffold tube 48.3mm 4.50m	16.2	682022000
Scaffold tube 48.3mm 5.00m	18.0	682023000
Scaffold tube 48.3mm 5.50m	19.8	682024000
Scaffold tube 48.3mm 6.00m	21.6	682025000
Scaffold tube 48.3mmm	3.6	682001000
Gerüstrohr 48,3mm		
		
Galvanised		

Screw-on coupler 48mm 50	0.84	682002000
Anschraubkupplung 48mm 50		
		
Galvanised		
Width-across: 22 mm		
Follow fitting instructions!		

Swivel coupler 48mm	1.5	582560000
Drehkupplung 48mm		
		
Galvanised		
Width-across: 22 mm		
Follow fitting instructions!		

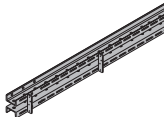
	[kg]	Article n°
Multi-purpose waling WS10 Top50 3.00m	58.9	580011000
Multi-purpose waling WS10 Top50 3.50m	68.4	580012000
Multi-purpose waling WS10 Top50 4.00m	79.4	580013000
Mehrzweckriegel WS10 Top50		
		
Painted blue		

Adjusting spindle M36	6.2	500663002
Höhenjustierspindel M36		
		
Galvanised		
Length: 31 cm		
Height: 29.2 cm		

Connecting pin 10cm	0.34	580201000
Verbindungsbolzen 10cm		
		
Galvanised		
Length: 14 cm		

Spring cotter 5mm	0.05	580204000
Federvorstecker 5mm		
		
Galvanised		
Length: 13 cm		

Waling-to-bracket holder 9-15cm	2.7	580625000
Riegelhalter 9-15cm		
		
Galvanised		

Framax wedge clamp	1.5	588152000
Framax-Spannklemme		
		
Galvanised		
Length: 21 cm		

Panel strut 340 IB	24.3	580365000
Elementstütze 340 IB		
consisting of:		
(A) Plumbing strut 340 IB	16.7	588696000
Galvanised		
Length: 190.8 - 341.8 cm		
(B) Adjusting strut 120 IB	7.6	588248500
Galvanised		
Length: 81.5 - 130.6 cm		

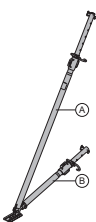
		
Galvanised		
Delivery condition: folded closed		

Prop head EB	3.1	588244500
Stützenkopf EB		
		
Galvanised		
Length: 40.8 cm		
Width: 11.8 cm		
Height: 17.6 cm		

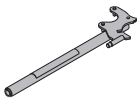
Universal dismantling tool	3.7	582768000
Universal-Lösewerkzeug		
		
Galvanised		
Length: 75.5 cm		

	[kg]	Article n°
Star screw Sternschraube	0.75	580425000
 Galvanised Length: 17 cm		

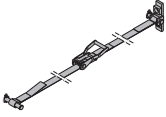
Wind bracing MF/150F/K 6.00m Windabspannung MF/150F/K 6,00m	4.7	580665000
 Galvanised		

Pin D16/112 Steckbolzen D16/112	0.29	500403330
 Galvanised Length: 16 cm		

Top scaffold bracket L Betonierkonsole L	12.6	587153500
 Galvanised Length: 101 cm Height: 159 cm		

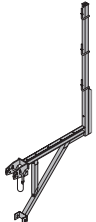
Universal bracket 90 Universal-Konsole 90	30.4	580476000
 Galvanised Length: 121 cm Height: 235 cm		

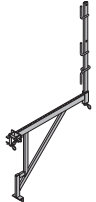
Framax bracket 90 Framax-Konsole 90	12.5	588167000
 Galvanised Width: 103 cm Height: 185 cm Delivery condition: railing included		

Railing clamp XP 40cm Geländerzwinge XP 40cm	7.7	586456000
 Galvanised Height: 73 cm		

	[kg]	Article n°
Handrail post XP 1.20m Geländersteher XP 1,20m	4.1	586460000
 Galvanised Height: 118 cm		

Toeboard holder XP 1.20m Fußwehrhalter XP 1,20m	0.64	586461000
 Galvanised Height: 21 cm		

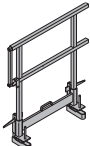
Side handrail clamping unit T Seitenschutzgeländer T	29.1	580488000
 Galvanised Length: 115 - 175 cm Height: 112 cm		

Handrail clamp S Schutzgeländerzwinge S	11.5	580470000
 Galvanised Height: 123 - 171 cm		

Universal railing shackle Universal-Geländerbügel	3.0	580478000
 Galvanised Height: 20 cm		

Scaffold tube connection Gerüstrohranschluss	0.27	584375000
 Galvanised Height: 7 cm		

Doka 4-part chain 3.20m Doka-Vierstrangkette 3,20m	15.0	588620000
 Follow the directions in the "Operating Instructions!"		CE

Lifting beam 110kN 6.00m Umsetzbalken 110kN 6,00m	136.5	586359000
 Galvanised Length: 626 cm Follow the directions in the "Operating Instructions!"		CE

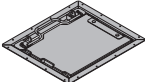
Manhole B 70/60cm Bühndurchstieg B 70/60cm	22.0	581530000
 Steel parts galvanised Timber parts varnished yellow Length: 81 cm Width: 71 cm		

Warning sign "No entry" 300x300mm 0.70 **581575000**
 Verbotsschild "Zutritt Verboten" 300x300mm



Doka personal fall-arrest set 3.6 **583022000**
 Doka-Auffanggurt

Follow the directions in the
 "Operating Instructions"!



Universal tool box 15.0 9.1 **580392000**
 Universal-Werkzeugbox 15,0

included in scope of supply:

- (A) **Reversible ratchet 1/2"** 0.73 **580580000**
 Galvanised
 Length: 30 cm
- (B) **Fork wrench 13/17** 0.08 **580577000**
- (C) **Fork wrench 22/24** 0.22 **580587000**
- (D) **Fork wrench 30/32** 0.80 **580897000**
- (E) **Fork wrench 36/41** 1.0 **580586000**
- (F) **Ring spanner 17/19** 0.27 **580590000**
- (G) **Square nut 22** 0.31 **580589000**
- (H) **Box spanner 41** 0.99 **580585000**
- (I) **Extension 11cm 1/2"** 0.20 **580581000**
- (J) **Extension 22cm 1/2"** 0.31 **580582000**
- (K) **Universal joint coupling 1/2"** 0.16 **580583000**
- (L) **Box nut 19 1/2" L** 0.16 **580598000**
- (M) **Box nut 13 1/2"** 0.06 **580576000**
- (N) **Box nut 24 1/2"** 0.12 **580584000**
- (O) **Box nut 30 1/2"** 0.20 **580575000**
- (P) **Positioning cone spanner 15.0 DK** 0.30 **580579000**
 Galvanised
 Length: 8 cm
 Width-across: 30 mm

