

	[kg]	Article n°
Top100 tec waling WU14 0.50m	15.2	586901000
Top100 tec waling WU14 0.75m	21.4	586902000
Top100 tec waling WU14 1.00m	28.6	586903000
Top100 tec waling WU14 1.25m	35.8	586904000
Top100 tec waling WU14 1.50m	43.3	586905000
Top100 tec waling WU14 1.75m	51.2	586906000
Top100 tec waling WU14 2.00m	57.8	586907000
Top100 tec waling WU14 2.25m	67.8	586908000
Top100 tec waling WU14 2.50m	72.2	586909000
Top100 tec waling WU14 2.75m	79.0	586910000
Top100 tec waling WU14 3.00m	85.8	586911000
Top100 tec waling WU14 3.50m	100.7	586912000
Top100 tec waling WU14 4.00m	114.2	586913000
Top100 tec waling WU14 4.50m	119.0	586914000
Top100 tec waling WU14 5.00m	144.5	586915000
Top100 tec waling WU14 5.50m	166.5	586916000
Top100 tec waling WU14 6.00m	182.2	586917000
Top100 tec-Riegel WU14		

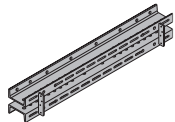

Painted blue

Top100 tec outside corner waling	76.8	586919000
Top100 tec-Außeneckriegel		



Painted blue

Leg length: 110 cm

Top100 tec inside corner waling	23.4	586918000
Top100 tec-Inneneckriegel		



Painted blue

Leg length: 45.9 cm

Top100 tec corner profile 1.15m	4.7	586921000
Top100 tec corner profile 2.90m	12.5	586920000
Top100 tec corner profile 3.50m	14.5	586933000
Top100 tec-Eckprofil		

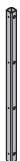

Galvanised, powder-coated

Waling clamp H20	0.22	580114000
Riegelklammer H20		



Galvanised

Width: 8 cm

Width-across: 13 mm

Flange clamp G	1.1	580120000
Flanschklammer G		



Galvanised

Width: 13 cm

Width-across: 19 mm

Beam screw S 8/60	0.06	580116000
Riegelverschraubung S 8/60		



Galvanised

Length: 7 cm

Width-across: 13 mm

Beam screw H 8/70	0.06	580117000
Riegelverschraubung H 8/70		



Galvanised

Length: 8 cm

Width-across: 13 mm

Fastening plate	2.7	580110000
Anschraublasche		



Painted blue

Width: 13 cm

Height: 15 cm

Flange claw	1.0	580137000
Flanschkralle		



Galvanised

Width: 17 cm

Width-across: 19 mm

Lifting bracket	6.2	580460000
Kranöse		



Galvanised

Height: 59 cm

Top100 tec formwork element connector	11.6	586923000
Top100 tec-Elementverbinder		

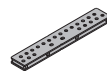

Painted blue

Length: 76 cm

Top100 tec adjustable waling extension	20.9	586924000
Top100 tec-Ausgleichslasche		

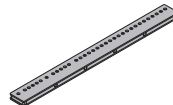

Painted blue

Length: 137 cm

Top100 tec ply joint adjuster	14.3	586935000
Top100 tec-Einrichtlasche		

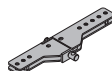

Galvanised

Length: 76 cm

Beam clamp Top50	1.2	580081000
Trägerklammer Top50		



Painted blue

Height: 15 cm

Top100 tec anchoring plate	7.1	586925000
Top100 tec-Ankerungslasche		



Painted blue

Length: 56 cm

Top100 tec internal angle plate	25.8	586926000
Top100 tec-Innenecklasche		

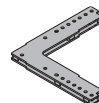

Painted blue

Leg length: 70 cm

Top100 tec transition plate 21mm	15.5	586927000
Top100 tec-Übergangslasche 21mm		

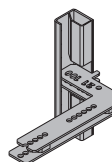



Painted blue

Height: 51 cm

	[kg]	Article n°
Top100 tec angle tie bracket WU14 Top100 tec-Winkelspanner WU14	8.9	586928000
 Painted blue Length: 26.9 cm		

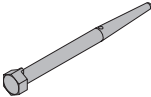
Connecting pin 10cm Verbindungsbolzen 10cm	0.34	580201000
 Galvanised Length: 14 cm		

Connecting pin 25cm Verbindungsbolzen 25cm	0.58	580202000
 Galvanised Length: 25 cm		

Spring cotter 5mm Federvorstecker 5mm	0.05	580204000
 Galvanised Length: 13 cm		

Stacking plate H20 Aufstocklasche H20	8.3	580310000
 Galvanised Length: 68.8 cm		

Joint plate 3.00m Joint plate 4.00m Ausgleichsschiene	36.8 47.7	580332000 580334000
 Powder-coated, blue		

T ledge 21/42 2.00m T-Leiste 21/42 2,00m	0.34	580196000
 Grey		

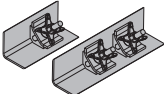
Box-out clamp 24cm Box-out clamp 25cm Box-out clamp 30cm Aussparungsklemme	3.3 3.4 3.8	580063000 580064000 580065000
 Galvanised Leg length: 10 cm		

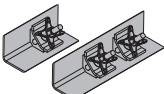
Box-out clamp type 1cm Box-out clamp type 2cm Aussparungsklemmecm	20.0 17.4	580066000 580067000
 Painted blue Leg length: 10 cm		

	[kg]	Article n°
Wall-formwork support angle Auflagewinkel Wandschalung	6.6	588967000
 Galvanised Length: 15.8 cm Width: 12 cm Height: 11.2 cm		

Panel strut 340 IB Elementstütze 340 IB consisting of:	24.3	580365000
(A) Plumbing strut 340 IB Galvanised Length: 190.8 - 341.8 cm	16.7	588696000
(B) Adjusting strut 120 IB Galvanised Length: 81.5 - 130.6 cm	7.6	588248500

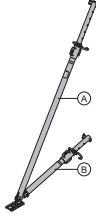
 Galvanised Delivery condition: folded closed		
---	--	--

Panel strut 540 IB Elementstütze 540 IB consisting of:	41.4	580366000
(A) Plumbing strut 540 IB Galvanised Length: 310.5 - 549.2 cm	30.7	588697000
(B) Adjusting strut 220 IB Galvanised Length: 172.5 - 221.1 cm	10.9	588251500

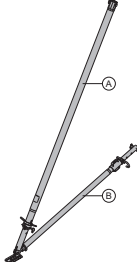
 Galvanised Delivery condition: folded closed		
--	--	--

	[kg]	Article n°
Eurex 60 550 Eurex 60 550		
depending on length, comprising:		
(A) Plumbing strut Eurex 60 550 Powder-coated, blue Aluminium Length: 343 - 553 cm	42.5	582658000
(B) Extension Eurex 60 2.00m Powder-coated, blue Aluminium Length: 250 cm	21.3	582651000
(C) Coupler Eurex 60 Aluminium Length: 100 cm Diameter: 12.8 cm	8.6	582652000
(D) Connector Eurex 60 IB Galvanised Length: 15 cm Width: 15 cm Height: 30 cm	4.2	582657500
(E) Plumbing strut shoe Eurex 60 EB Galvanised Length: 31 cm Width: 12 cm Height: 33 cm	8.0	582660500
(F) Adjusting strut 540 Eurex 60 IB Galvanised Length: 303.5 - 542.2 cm	27.8	582659500

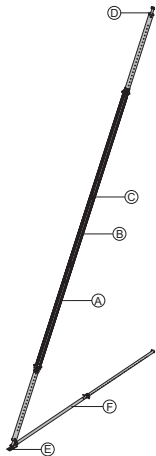

Delivery condition: separate parts

Prop head EB Stützenkopf EB	3.1	588244500
Galvanised Length: 40.8 cm Width: 11.8 cm Height: 17.6 cm		



Prop head Eurex 60 Top50 Stützenkopf Eurex 60 Top50	7.1	582665000
Galvanised Height: 50 cm		



Doka express anchor 16x125mm Doka-Expressanker 16x125mm	0.31	588631000
Galvanised Length: 18 cm Follow fitting instructions!		



Doka coil 16mm Doka-Coil 16mm	0.009	588633000
Galvanised Diameter: 1.6 cm		



Gauge for Doka express anchor 16x125mm Lehre Doka-Expressanker 16x125mm	0.03	588632000
Black Length: 3 cm Diameter: 2 cm		



Xsafe plus lifting adapter for beam formwork Xsafe plus-Umsetzadapter Trägerschalung	14.0	586439000
Galvanised Width: 66 cm Height: 89 cm		

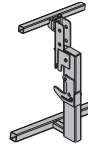

Universal bracket 90 Universal-Konsole 90	30.4	580476000
Galvanised Length: 121 cm Height: 235 cm		

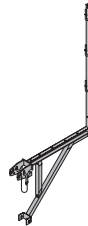

Universal corner bracket 90 right Universal corner bracket 90 left Universa-Eckkonsole 90	29.5 29.5	580071000 580070000
Galvanised Length: 152 cm Height: 235 cm		



Top scaffold bracket L Betonierkonsole L	12.6	587153500
Galvanised Length: 101 cm Height: 159 cm		



Bracket planking 60/250cm Bracket planking 90/250cm Konsolenbelag	48.5 61.3	583029000 583031000
Steel parts galvanised Timber parts varnished yellow		

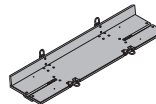

Bracket railing 240-270cm Konsolengeländer 240-270cm	22.5	583032000
Galvanised		



Universal railing shackle Universal-Geländerbügel	3.0	580478000
Galvanised Height: 20 cm		



	[kg]	Article n°
Scaffold tube connection Gerüstrohranschluss	0.27	584375000
 Galvanised Height: 7 cm		

Scaffold tube 48.3mm 0.50m	1.7	682026000
Scaffold tube 48.3mm 1.00m	3.6	682014000
Scaffold tube 48.3mm 1.50m	5.4	682015000
Scaffold tube 48.3mm 2.00m	7.2	682016000
Scaffold tube 48.3mm 2.50m	9.0	682017000
Scaffold tube 48.3mm 3.00m	10.8	682018000
Scaffold tube 48.3mm 3.50m	12.6	682019000
Scaffold tube 48.3mm 4.00m	14.4	682021000
Scaffold tube 48.3mm 4.50m	16.2	682022000
Scaffold tube 48.3mm 5.00m	18.0	682023000
Scaffold tube 48.3mm 5.50m	19.8	682024000
Scaffold tube 48.3mm 6.00m	21.6	682025000
Scaffold tube 48.3mmm	3.6	682001000
Gerüstrohr 48,3mm		

 Galvanised		
---	--	--

Screw-on coupler 48mm 50 Anschraubkupplung 48mm 50	0.84	682002000
 Galvanised Width-across: 22 mm Follow fitting instructions!		

Swivel coupler 48mm Drehkupplung 48mm	1.5	582560000
 Galvanised Width-across: 22 mm Follow fitting instructions!		

Handrail post XP 1.20m Geländersteher XP 1,20m	4.1	586460000
 Galvanised Height: 118 cm		

Toeboard holder XP 1.20m Fußwehrhalter XP 1,20m	0.64	586461000
 Galvanised Height: 21 cm		

Railing clamp XP 40cm Geländerzwinge XP 40cm	7.7	586456000
 Galvanised Height: 73 cm		

	[kg]	Article n°
Protective grating XP 2.70x1.20m	22.2	586450000
Protective grating XP 2.50x1.20m	20.5	586451000
Protective grating XP 2.00x1.20m	17.4	586452000
Protective grating XP 1.20x1.20m	12.0	586453000
Schutzgitter XP		

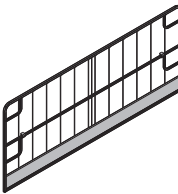
 Galvanised		
--	--	--

Velcro fastener 30x380mm Klettverschluss 30x380mm	0.02	586470000
 Yellow		

Timber-beam formwork adapter XP Trägerschalungsadapter XP	9.5	586476000
 Galvanised Height: 83.5 cm		

Handrail clamp S Schutzgeländerzwinge S	11.5	580470000
---	------	------------------

 Galvanised Height: 123 - 171 cm		
---	--	--

Handrail post 1.10m Schutzgeländer 1,10m	5.5	584384000
--	-----	------------------

 Galvanised Height: 134 cm		
--	--	--

Side handrail clamping unit T Seitenschutzgeländer T	29.1	580488000
--	------	------------------

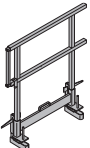
 Galvanised Length: 115 - 175 cm Height: 112 cm		
--	--	--

Handrail post T 1.80m Einschubgeländer T 1,80m	17.7	584373000
--	------	------------------

 Galvanised		
--	--	--

	[kg]	Article n°
Toeboard holder T 1.80m Fußwehrhalter T 1,80m	0.53	584392000
	Galvanised Height: 13.5 cm	

Doka 4-part chain 3.20m Doka-Vierstrangkette 3,20m	15.0	588620000
	Follow the directions in the "Operating Instructions"!	CE

Universal strut T5/5mm Strebe T5/5mm	6.5	584311000
	Painted blue Weight per linear metre	

Spindle strut GS T5 65/101cm Spindelstrebe GS T5 65/101cm	9.1	584356000
	Galvanised	

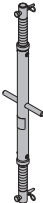
Spindle strut T6 73/110cm Spindle strut T6 100/150cm Spindelstrebe T6	10.2 12.5	584355000 584323000
	Galvanised	

Spindle strut GS T6 95/140cm Spindelstrebe GS T6 95/140cm	10.3	584340000
	Galvanised	

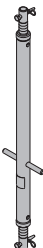
Spindle strut T7 75/110cm	13.2	584308000
Spindle strut T7 100/150cm	16.8	584309000
Spindle strut T7 150/200cm	21.6	584324000
Spindle strut T7 200/250cm	26.2	584325000
Spindle strut T7 250/300cm	29.4	584326000
Spindle strut T7 305/355cm Spindelstrebe T7	35.0	584327000
	Galvanised	

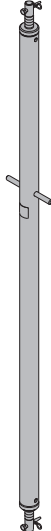
	[kg]	Article n°
Spindle strut T10 350/400cm	57.5	584328000
Spindle strut T10mm Spindelstrebe T10	14.6	584391000
		

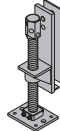
Height adjuster for formwork beams Höhenjustierung für Schalungsträger	11.9	580218000
	Galvanised Height: 46 cm	

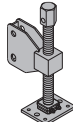
Height adjuster WS10-WU16 Höhenjustierung WS10-WU16	10.1	580206500
	Galvanised Height: 45 cm	

Adjusting spindle M36 Höhenjustierspindel M36	6.2	500663002
	Galvanised Length: 31 cm Height: 29.2 cm	

Adjusting plate T Justierlasche T	6.5	584393000
	Painted blue Length: 23.5 cm	

	[kg]	Article n°
Tool box GF GF-Werkzeugbox included in scope of supply:	6.5	580390000
(A) Reversible ratchet 1/2" Galvanised Length: 30 cm	0.73	580580000
(B) Fork wrench 13/17	0.08	580577000
(C) Fork wrench 22/24	0.22	580587000
(D) Fork wrench 30/32	0.80	580897000
(E) Ring spanner 17/19	0.27	580590000
(F) Extension 11cm 1/2"	0.20	580581000
(G) Extension 22cm 1/2"	0.31	580582000
(H) Universal joint coupling 1/2"	0.16	580583000
(I) Box nut 19 1/2" L	0.16	580598000
(J) Box nut 13 1/2"	0.06	580576000
(K) Box nut 24 1/2"	0.12	580584000
(L) Box nut 30 1/2"	0.20	580575000

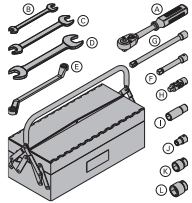

Reversible ratchet 3/4" Umschaltknarre 3/4"	1.5	580894000
---	-----	------------------

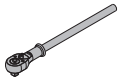

Galvanised
Length: 50 cm

Box nut 50 3/4" Stecknuss 50 3/4"	0.81	581449000
---	------	------------------



Filler neck GF SCC GF-Füllstutzen SCC	39.0	580217000
---	------	------------------

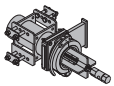

Galvanised
Length: 66 cm

Panel closure tool D125 SCC Sperrschieber D125 SCC	18.0	588127000
--	------	------------------



Galvanised
Length: 18 cm
Width: 33 cm
Height: 27 cm

Top100 tec assembly angle Top100 tec-Montagelasche	6.6	586929000
--	-----	------------------



Galvanised
Length: 53.2 cm
Width: 48.2 cm

Strip tensioner B 6.00m Bandzwinde B 6,00m	3.3	580394500
--	-----	------------------

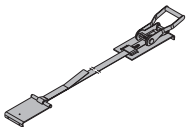

Galvanised

Positioning railm Führungsschienem	1.8	580079000
--	-----	------------------

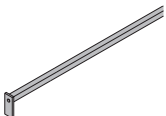

Painted blue
Weight per linear metre

	[kg]	Article n°
Top100 tec hole gauge Top100 tec-Bohrplatte	2.7	586930000

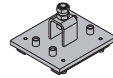

Painted blue
Length: 17 cm
Width: 15 cm

Angle connector 9x5cm Winkelverbinder 9x5cm	0.22	580381000
---	------	------------------



Galvanised

Rafter plate right Rafter plate left Sparrenpfettenanker	0.09	582521000
	0.09	582522000



Galvanised
Length: 17 cm

H20 screw-on bracket for formwork sheets Schalhaut-Schraubwinkel H20	0.19	586256000
--	------	------------------

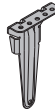

Galvanised
Height: 19.2 cm

Double scraper Xlife 100/150mm 1.40m Doppelschaber Xlife 100/150mm 1,40m	2.8	588674000
--	-----	------------------

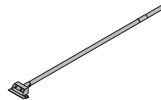

Tie-off connector type A Anhängewinkel Typ A	0.96	581641000
--	------	------------------



Galvanised
Length: 13.7 cm

Doka personal fall-arrest set Doka-Auffanggurt	3.6	583022000
--	-----	------------------



Follow the directions in the
"Operating Instructions"!

