

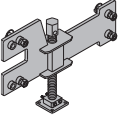

	[kg]	Article n°
<b>Facade waling WU14 6.00m</b> Fassadenriegel	189.2	<b>580691000</b>
 Painted blue		

<b>Facade precast member clamp H</b> Fassaden-Fertigteilklemme H	26.2	<b>580693000</b>
 Galvanised Length: 70 cm Height: 41 cm Width-across: 50 mm		

<b>Facade precast member clamp V</b> Fassaden-Fertigteilklemme V	8.1	<b>580694000</b>
 Galvanised Length: 70 cm Height: 41 cm Width-across: 50 mm		

<b>Facade precast member clamp O</b> Fassaden-Fertigteilklemme O	4.9	<b>580698000</b>
 Galvanised Length: 59 cm Height: 22 cm		

<b>Facade waling connector</b> Fassaden-Riegelverbinder	4.7	<b>580695000</b>
 Galvanised Length: 26 cm Height: 25 cm		

<b>Facade anchor socket 15.0</b> Fassaden-Ankermuffe 15,0	3.5	<b>580696000</b>
 Galvanised Length: 33 cm Width: 12 cm		

<b>Eye-lug anchor 15.0 without tie rod</b> Ösenanker 15,0 ohne Ankerstab	1.2	<b>580649000</b>
 Galvanised Length: 11 cm		

<b>Multi-purpose waling WS10 Top50 0.50m</b>	10.2	<b>580001000</b>
<b>Multi-purpose waling WS10 Top50 0.75m</b>	14.9	<b>580002000</b>
<b>Multi-purpose waling WS10 Top50 1.00m</b>	19.6	<b>580003000</b>
<b>Multi-purpose waling WS10 Top50 1.25m</b>	24.7	<b>580004000</b>
<b>Multi-purpose waling WS10 Top50 2.50m</b>	48.7	<b>580009000</b>
Mehrzweckriegel WS10 Top50		
 Painted blue		

<b>Multi-purpose waling WU12 Top50 1.50m</b> Mehrzweckriegel WU12 Top50 1,50m	37.5	<b>580020000</b>
 Painted blue		

<b>Flange clamp H20</b> Flanschklammer H20	1.0	<b>580135000</b>
 Galvanised Width: 13 cm Width-across: 19 mm		

	[kg]	Article n°
<b>Protective cap H20</b> Stirmschuh H20	0.36	<b>587248000</b>
 Galvanised Length: 20 cm Width: 7 cm		

<b>Lifting bracket</b> Kranöse	6.2	<b>580460000</b>
 Galvanised Height: 59 cm		

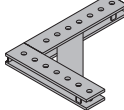
<b>Corner connecting plate 90/50</b> Winkellasche 90/50	13.8	<b>580603000</b>
 Painted blue Length: 51 cm Width: 40 cm		

<b>Universal angle tie bracket</b> Universal-Winkelspanner	4.4	<b>580604000</b>
 Painted blue Length: 20 cm		

<b>Connecting pin 10cm</b> Verbindungsbolzen 10cm	0.34	<b>580201000</b>
 Galvanised Length: 14 cm		

<b>Spring cotter 5mm</b> Federvorstecker 5mm	0.05	<b>580204000</b>
 Galvanised Length: 13 cm		

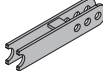
<b>Facade waling holder</b> Fassaden-Riegelhalter	2.3	<b>580674000</b>
 Galvanised Length: 31 cm		

<b>Facade strut holder</b> Fassaden-Stützenhalter	2.0	<b>580675000</b>
 Galvanised Length: 30 cm		

<b>Plumbing strut 340 IB</b> Justierstütze 340 IB	16.7	<b>588696000</b>
 Galvanised Length: 190.8 - 341.8 cm		

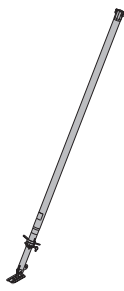
	[kg]	Article n°
<b>Plumbing strut 540 IB</b> Justierstütze 540 IB	30.7	<b>588697000</b>
 Galvanised Length: 310.5 - 549.2 cm		

<b>Strut shoe EB</b> Strebenschuh EB	0.93	<b>588946000</b>
 Galvanised Width: 8 cm Height: 13 cm		

<b>Panel strut 340 IB</b> Elementstütze 340 IB consisting of:	24.3	<b>580365000</b>
(A) <b>Plumbing strut 340 IB</b> Galvanised Length: 190.8 - 341.8 cm	16.7	<b>588696000</b>
(B) <b>Adjusting strut 120 IB</b> Galvanised Length: 81.5 - 130.6 cm	7.6	<b>588248500</b>

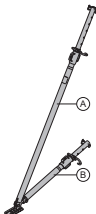
 Galvanised Delivery condition: folded closed		
--	--	--

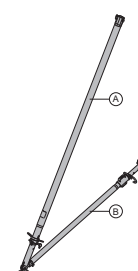
<b>Panel strut 540 IB</b> Elementstütze 540 IB consisting of:	41.4	<b>580366000</b>
(A) <b>Plumbing strut 540 IB</b> Galvanised Length: 310.5 - 549.2 cm	30.7	<b>588697000</b>
(B) <b>Adjusting strut 220 IB</b> Galvanised Length: 172.5 - 221.1 cm	10.9	<b>588251500</b>
 Galvanised Delivery condition: folded closed		

<b>Prop head EB</b> Stützenkopf EB	3.1	<b>588244500</b>
 Galvanised Length: 40.8 cm Width: 11.8 cm Height: 17.6 cm		

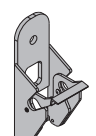
<b>Docking head</b> Andockkopf	3.3	<b>588690000</b>
 Galvanised Length: 29.5 cm		

<b>Docking set</b> Andockset	0.66	<b>588694000</b>
 Galvanised Length: 16 cm		

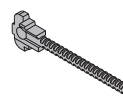
<b>Docking screw</b> Andockschraube	0.60	<b>588698000</b>
 Galvanised Length: 30.5 cm		

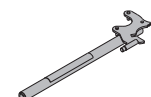
<b>Universal dismantling tool</b> Universal-Lösewerkzeug	3.7	<b>582768000</b>
 Galvanised Length: 75.5 cm		

<b>Doka express anchor 16x125mm</b> Doka-Expressanker 16x125mm	0.31	<b>588631000</b>
 Galvanised Length: 18 cm Follow fitting instructions!		

<b>Doka coil 16mm</b> Doka-Coil 16mm	0.009	<b>588633000</b>
 Galvanised Diameter: 1.6 cm		

<b>Gauge for Doka express anchor 16x125mm</b> Lehre Doka-Expressanker 16x125mm	0.03	<b>588632000</b>
 Black Length: 3 cm Diameter: 2 cm		

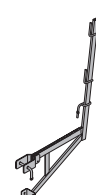
<b>Top scaffold bracket L</b> Betonierkonsole L	12.6	<b>587153500</b>
 Galvanised Length: 101 cm Height: 159 cm		

<b>Universal bracket 90</b> Universal-Konsole 90	30.4	<b>580476000</b>
 Galvanised Length: 121 cm Height: 235 cm		

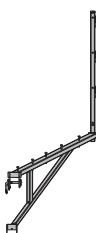
	[kg]	Article n°
<b>Universal corner bracket 90 right</b>	29.5	<b>580071000</b>
<b>Universal corner bracket 90 left</b>	29.5	<b>580070000</b>
Universa-Eckkonsole 90		
		
Galvanised		
Length: 152 cm		
Height: 235 cm		

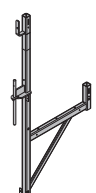
<b>Cavity wall bracket 60</b>	18.9	<b>583033000</b>
Hohlwand-Konsole 60		
		
Galvanised		
Length: 73 cm		
Height: 174 cm		

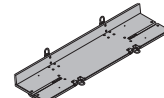
<b>Bracket planking 60/250cm</b>	48.5	<b>583029000</b>
<b>Bracket planking 60/270cm</b>	52.5	<b>583030000</b>
<b>Bracket planking 90/250cm</b>	61.3	<b>583031000</b>
Konsolenbelag		
		
Steel parts galvanised		
Timber parts varnished yellow		

<b>Bracket railing 240-270cm</b>	22.5	<b>583032000</b>
Konsolengeländer 240-270cm		
		
Galvanised		

<b>Universal railing shackle</b>	3.0	<b>580478000</b>
Universal-Geländerbügel		
		
Galvanised		
Height: 20 cm		

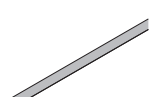
<b>Scaffold tube 48.3mm 0.50m</b>	1.7	<b>682026000</b>
<b>Scaffold tube 48.3mm 1.00m</b>	3.6	<b>682014000</b>
<b>Scaffold tube 48.3mm 1.50m</b>	5.4	<b>682015000</b>
<b>Scaffold tube 48.3mm 2.00m</b>	7.2	<b>682016000</b>
<b>Scaffold tube 48.3mm 2.50m</b>	9.0	<b>682017000</b>
<b>Scaffold tube 48.3mm 3.00m</b>	10.8	<b>682018000</b>
<b>Scaffold tube 48.3mm 3.50m</b>	12.6	<b>682019000</b>
<b>Scaffold tube 48.3mm 4.00m</b>	14.4	<b>682021000</b>
<b>Scaffold tube 48.3mm 4.50m</b>	16.2	<b>682022000</b>
<b>Scaffold tube 48.3mm 5.00m</b>	18.0	<b>682023000</b>
<b>Scaffold tube 48.3mm 5.50m</b>	19.8	<b>682024000</b>
<b>Scaffold tube 48.3mm 6.00m</b>	21.6	<b>682025000</b>
<b>Scaffold tube 48.3mm .....m</b>	3.6	<b>682001000</b>
Gerüstrohr 48,3mm		
		
Galvanised		

<b>Scaffold tube connection</b>	0.27	<b>584375000</b>
Gerüstrohranschluss		
		
Galvanised		
Height: 7 cm		

	[kg]	Article n°
<b>Handrail clamp S</b>	11.5	<b>580470000</b>
Schutzgeländerzwinge S		
		
Galvanised		
Height: 123 - 171 cm		

<b>Handrail post 1.10m</b>	5.5	<b>584384000</b>
Schutzgeländer 1,10m		
		
Galvanised		
Height: 134 cm		

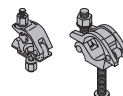

<b>Attachable sleeve 24mm</b>	0.03	<b>584385000</b>
Steckhülse 24mm		
		
Grey		
Length: 16.5 cm		
Diameter: 2.7 cm		

<b>Screw sleeve 20.0</b>	0.03	<b>584386000</b>
Schraubhülse 20,0		
		
Yellow		
Length: 20 cm		
Diameter: 3.1 cm		

<b>Screw-on coupler 48mm 50</b>	0.84	<b>682002000</b>
<b>Screw-on coupler 48mm 95</b>	0.88	<b>586013000</b>
Anschraubkupplung		
		
Galvanised		
Width-across: 22 mm		
Follow fitting instructions!		

<b>Swivel coupler 48mm</b>	1.5	<b>582560000</b>
Drehkupplung 48mm		
		
Galvanised		
Width-across: 22 mm		
Follow fitting instructions!		

<b>Normal coupler 48mm</b>	1.2	<b>682004000</b>
Normalkupplung 48mm		
		
Galvanised		
Width-across: 22 mm		
Follow fitting instructions!		

<b>Doka 4-part chain 3.20m</b>	15.0	<b>588620000</b>
Doka-Vierstrangkette 3,20m		
		
Follow the directions in the "Operating Instructions"!		
		

<b>Tool box GF</b> GF-Werkzeugbox included in scope of supply:	6.5	<b>580390000</b>
(A) <b>Reversible ratchet 1/2"</b> Galvanised Length: 30 cm	0.73	<b>580580000</b>
(B) <b>Fork wrench 13/17</b>	0.08	<b>580577000</b>
(C) <b>Fork wrench 22/24</b>	0.22	<b>580587000</b>
(D) <b>Fork wrench 30/32</b>	0.80	<b>580897000</b>
(E) <b>Ring spanner 17/19</b>	0.27	<b>580590000</b>
(F) <b>Extension 11cm 1/2"</b>	0.20	<b>580581000</b>
(G) <b>Extension 22cm 1/2"</b>	0.31	<b>580582000</b>
(H) <b>Universal joint coupling 1/2"</b>	0.16	<b>580583000</b>
(I) <b>Box nut 19 1/2" L</b>	0.16	<b>580598000</b>
(J) <b>Box nut 13 1/2"</b>	0.06	<b>580576000</b>
(K) <b>Box nut 24 1/2"</b>	0.12	<b>580584000</b>
(L) <b>Box nut 30 1/2"</b>	0.20	<b>580575000</b>

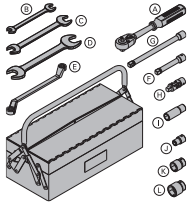

<b>Reversible ratchet 3/4"</b> Umschaltknarre 3/4"	1.5	<b>580894000</b>
---	-----	------------------

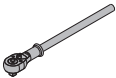

Galvanised  
Length: 50 cm

<b>Box nut 50 3/4"</b> Stecknuss 50 3/4"	0.81	<b>581449000</b>
---	------	------------------



<b>Friction type ratchet SW27</b> Freilaufknarre SW27	0.49	<b>581855000</b>
--	------	------------------

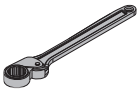

manganese-phosphated  
Length: 30 cm

<b>Box spanner 27 0.65m</b> Steckschlüssel 27 0,65m	1.9	<b>581854000</b>
--	-----	------------------

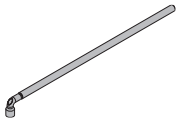

Galvanised

<b>Tie-off connector type A</b> Anhängewinkel Typ A	0.96	<b>581641000</b>
--	------	------------------



Galvanised  
Length: 13.7 cm

<b>Doka personal fall-arrest set</b> Doka-Auffanggurt	3.6	<b>583022000</b>
--	-----	------------------



Follow the directions in the  
"Operating Instructions"!

