

	[kg]	Article n°
Staxo 100 frame 0.90m	24.0	582302000
Staxo 100 frame 1.20m	28.0	582301000
Staxo 100 frame 1.80m	37.0	582300000
Staxo 100-Rahmen		

Galvanised



Diagonal cross 9.060	3.1	582322000
Diagonal cross 9.100	4.1	582772000
Diagonal cross 9.150	5.2	582773000
Diagonal cross 9.175	6.1	582334000
Diagonal cross 9.200	6.6	582774000
Diagonal cross 9.250	7.7	582775000
Diagonal cross 9.300	9.0	582323000
Diagonal cross 12.060	4.0	582324000
Diagonal cross 12.100	4.6	582610000
Diagonal cross 12.150	5.7	582612000
Diagonal cross 12.175	6.3	582335000
Diagonal cross 12.200	6.9	582614000
Diagonal cross 12.250	8.3	582616000
Diagonal cross 12.300	9.3	582325000
Diagonal cross 18.100	6.1	582620000
Diagonal cross 18.150	6.9	582622000
Diagonal cross 18.175	7.8	582336000
Diagonal cross 18.200	7.8	582624000
Diagonal cross 18.250	9.1	582626000
Diagonal cross 18.300	10.3	582326000
Diagonalkreuz		

Galvanised

Delivery condition: folded closed



Diagonal cross H 9.100	5.7	582337000
Diagonal cross H 9.150	7.2	582338000
Diagonal cross H 9.200	9.3	582339000
Diagonal cross H 9.250	11.3	582340000
Diagonal cross H 12.100	5.8	582341000
Diagonal cross H 12.150	7.5	582342000
Diagonal cross H 12.200	9.3	582343000
Diagonal cross H 12.250	10.5	582344000
Diagonalkreuz H		

Galvanised

Delivery condition: folded closed

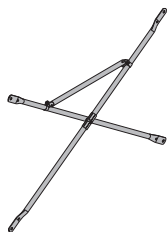

<b>U-head D</b> Gabelkopf D	6.7	582709000
--------------------------------	-----	-----------

Galvanised

Length: 20 cm  
Width: 22 cm  
Height: 37 cm



<b>4-way screw-jack head</b> Vierwegkopfspindel	10.4	582638000
----------------------------------------------------	------	-----------

Galvanised

Height: 86 cm

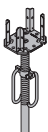

<b>Screw jack U-head</b> Kopfspindel	9.2	582636000
-----------------------------------------	-----	-----------

Galvanised  
Height: 74 cm



<b>Heavy-duty screw jack 70 top</b> Lastspindel 70 oben	9.2	582327000
------------------------------------------------------------	-----	-----------

Galvanised  
Height: 106 cm

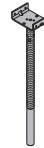

<b>Split nut B</b> Spannmutter B	2.0	582634000
-------------------------------------	-----	-----------

Galvanised



<b>Clamping plate D</b> Klemmplatte D	2.0	502709030
------------------------------------------	-----	-----------

Galvanised  
Length: 24 cm  
Width: 9 cm



<b>Wing nut 15.0</b> Flügelmutter 15,0	0.31	581961000
-------------------------------------------	------	-----------

Galvanised  
Length: 10 cm  
Height: 5 cm  
Width-across: 27 mm



**DIN**  
18216

<b>Locking rod 15.0 330mm</b> Quetschteil 15,0	0.48	582641000
---------------------------------------------------	------	-----------

Galvanised  
Width-across: 24 mm



<b>Dokamatic table Staxo spindle connector</b> Staxo-Spindelanschluss Dokamatic-Tisch	3.9	582347000
------------------------------------------------------------------------------------------	-----	-----------

Galvanised  
Length: 20.7 cm



<b>Wedge for screw jack ..... %</b> Spindelkeil ..... %	0.46	176071000
------------------------------------------------------------	------	-----------

Length: 20 cm  
Width: 16 cm



<b>Staxo 100 spindle adapter</b> Staxo 100-Spindeladapter	3.4	582351000
--------------------------------------------------------------	-----	-----------

Galvanised  
Height: 26 cm



<b>Super plate 15.0</b> Superplatte 15,0	1.1	581966000
---------------------------------------------	-----	-----------

Galvanised  
Height: 6 cm  
Diameter: 12 cm  
Width-across: 27 mm





**DIN**  
18216

<b>Staxo wedge support WS10</b> Staxo-Keilaufleger WS10	8.7	582796000
------------------------------------------------------------	-----	-----------

Galvanised  
Length: 31 cm  
Width: 15 cm  
Height: 23 cm



	[kg]	Article n°
<b>Staxo wedge support WU12/14</b> Staxo-Keilaufleger WU12/14	12.2	<b>582350000</b>
 Galvanised Length: 35.6 cm Width: 15 cm Height: 33.6 cm		

<b>Swivel bearing plate for screw jack U-head</b> Gelenkaufsatz Kopfspindel	5.2	<b>582799000</b>
 Galvanised Length: 20.8 cm Width: 15.0 cm Height: 14.4 cm		

<b>Screw jack foot</b> Fußspindel	9.0	<b>582637000</b>
 Galvanised Height: 69 cm		

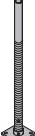
<b>Heavy-duty screw jack 70</b> Lastspindel 70	8.8	<b>582639000</b>
 Galvanised Height: 101 cm		

<b>Heavy-duty screw jack 130</b> Lastspindel 130	13.0	<b>582711000</b>
 Galvanised Height: 173 cm		

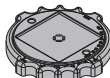
<b>Compensating plate</b> Ausgleichsplatte	1.2	<b>582239000</b>
 Orange Black Diameter: 30 cm		

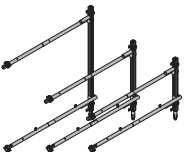
<b>Staxo 100 single leg 0.90m</b>	20.2	<b>582305000</b>
<b>Staxo 100 single leg 1.20m</b>	21.5	<b>582304000</b>
<b>Staxo 100 single leg 1.80m</b>	17.0	<b>582303000</b>
Staxo 100-Einzelstiel		
 Galvanised		

<b>Doka floor prop Eurex 60 550</b> Doka-Deckenstütze Eurex 60 550	47.0	<b>582650000</b>
 Aluminium Length: 345 - 555 cm		

	[kg]	Article n°
<b>Extension Eurex 60 2.00m</b> Verlängerung Eurex 60 2,00m	21.3	<b>582651000</b>
 Powder-coated, blue Aluminium Length: 250 cm		

<b>Coupler Eurex 60</b> Kupplungsstück Eurex 60	8.6	<b>582652000</b>
 Aluminium Length: 100 cm Diameter: 12.8 cm		

<b>U-head Eurex 60</b> Gabelkopf Eurex 60	2.9	<b>582656000</b>
 Galvanised Length: 22 cm Width: 20 cm Height: 12 cm		

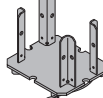
<b>4-way head Eurex 60</b> Vierwegkopf Eurex 60	4.5	<b>582655000</b>
 Galvanised Length: 25 cm Width: 21 cm Height: 21 cm		

<b>Plumbing strut Eurex 60 550</b> Justierstütze Eurex 60 550	42.5	<b>582658000</b>
 Powder-coated, blue Aluminium Length: 343 - 553 cm		

<b>Prop head Eurex 60 Top50</b> Stützenkopf Eurex 60 Top50	7.1	<b>582665000</b>
 Galvanised Height: 50 cm		

<b>Connector Eurex 60 IB</b> Verbindungsstück Eurex 60 IB	4.2	<b>582657500</b>
 Galvanised Length: 15 cm Width: 15 cm Height: 30 cm		

<b>Plumbing strut shoe Eurex 60 EB</b> Justierstützenfuß Eurex 60 EB	8.0	<b>582660500</b>
 Galvanised Length: 31 cm Width: 12 cm Height: 33 cm		

	[kg]	Article n°
<b>Swivel coupler 48mm Eurex 60</b> Drehkupplung 48mm Eurex 60	1.0	<b>582654000</b>
 Galvanised Width-across: 22 mm Follow fitting instructions!		

<b>Plumbing strut 340 IB</b> Justierstütze 340 IB	16.7	<b>588696000</b>
 Galvanised Length: 190.8 - 341.8 cm		

<b>Plumbing strut 340 IB EF</b> Justierstütze 340 IB EF	14.9	<b>588247500</b>
 Galvanised Length: 190.8 - 341.8 cm		

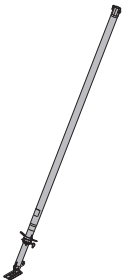
<b>Plumbing strut 540 IB</b> Justierstütze 540 IB	30.7	<b>588697000</b>
 Galvanised Length: 310.5 - 549.2 cm		

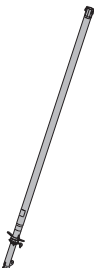
<b>Plumbing strut 540 IB EF</b> Justierstütze 540 IB EF	28.9	<b>588250500</b>
 Galvanised Length: 310.5 - 549.2 cm		

<b>Strut shoe EB</b> Strebenschuh EB	0.93	<b>588946000</b>
 Galvanised Width: 8 cm Height: 13 cm		

<b>Prop shoe EB</b> Stützenschuh EB	1.8	<b>588245500</b>
 Galvanised Length: 20 cm Width: 11 cm Height: 10 cm		

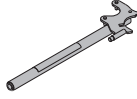
	[kg]	Article n°
<b>Universal dismantling tool</b> Universal-Lösewerkzeug	3.7	<b>582768000</b>
 Galvanised Length: 75.5 cm		

<b>Removable folding tripod 1.20m</b> Stützbein 1,20m	20.7	<b>586145000</b>
 Galvanised Height: 120 cm Delivery condition: folded closed		

<b>Doka express anchor 16x125mm</b> Doka-Expressanker 16x125mm	0.31	<b>588631000</b>
 Galvanised Length: 18 cm Follow fitting instructions!		

<b>Doka coil 16mm</b> Doka-Coil 16mm	0.009	<b>588633000</b>
 Galvanised Diameter: 1.6 cm		

<b>Gauge for Doka express anchor 16x125mm</b> Lehre Doka-Expressanker 16x125mm	0.03	<b>588632000</b>
 Black Length: 3 cm Diameter: 2 cm		

<b>Scaffold planking 60/100cm with manhole</b>	9.5	<b>582311500</b>
<b>Scaffold planking 60/150cm with manhole</b>	13.8	<b>582312500</b>
<b>Scaffold planking 60/175cm with manhole</b>	15.5	<b>582333500</b>
<b>Scaffold planking 60/200cm with manhole</b>	17.7	<b>582313500</b>
<b>Scaffold planking 60/250cm with manhole</b>	20.8	<b>582314500</b>
<b>Scaffold planking 60/300cm with manhole</b>	26.3	<b>582315500</b>
Gerüstbelag mit Durchstieg		

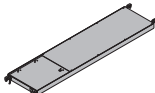
	Aluminium	
		

<b>Scaffold planking 30/100cm</b>	7.4	<b>582231000</b>
<b>Scaffold planking 30/150cm</b>	10.6	<b>582232000</b>
<b>Scaffold planking 30/200cm</b>	13.5	<b>582234000</b>
<b>Scaffold planking 30/250cm</b>	16.4	<b>582235000</b>
<b>Scaffold planking 30/300cm</b>	19.5	<b>582236000</b>
Gerüstbelag		

	Galvanised	
		

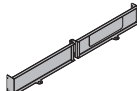
<b>Staxo 100 toeboard</b> Staxo 100-Fußwehr	5.5	<b>582329000</b>
 Galvanised Length: 131 cm Height: 15 cm		

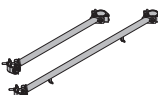
<b>Staxo 100 planking strut 1.00m</b> <b>Staxo 100 planking strut 1.50m</b> Staxo 100-Belagstrebe	6.1 9.0	<b>582348000</b> <b>582349000</b>
 Galvanised Width-across: 22 mm		

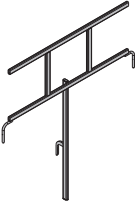
	[kg]	Article n°
<b>Staxo front railing</b> Staxo-Stirngeländer	10.5	<b>582316000</b>
	Galvanised Length: 140 cm Height: 152 cm	

<b>Staxo side railing 100</b>	17.5	<b>582317500</b>
<b>Staxo side railing 150</b>	20.0	<b>582318500</b>
<b>Staxo side railing 175</b>	23.2	<b>582331500</b>
<b>Staxo side railing 200</b>	24.1	<b>582319500</b>
<b>Staxo side railing 250</b>	27.5	<b>582320500</b>
<b>Staxo side railing 300</b> Staxo-Seitengeländer	31.1	<b>582321500</b>
	Galvanised Height: 152 cm	

<b>Spring locked connecting pin 16mm</b> Federbolzen 16mm	0.25	<b>582528000</b>
	Galvanised Length: 15 cm	

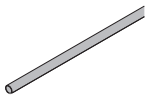
<b>Scaffold tube 48.3mm 0.50m</b>	1.7	<b>682026000</b>
<b>Scaffold tube 48.3mm 1.00m</b>	3.6	<b>682014000</b>
<b>Scaffold tube 48.3mm 1.50m</b>	5.4	<b>682015000</b>
<b>Scaffold tube 48.3mm 2.00m</b>	7.2	<b>682016000</b>
<b>Scaffold tube 48.3mm 2.50m</b>	9.0	<b>682017000</b>
<b>Scaffold tube 48.3mm 3.00m</b>	10.8	<b>682018000</b>
<b>Scaffold tube 48.3mm 3.50m</b>	12.6	<b>682019000</b>
<b>Scaffold tube 48.3mm 4.00m</b>	14.4	<b>682021000</b>
<b>Scaffold tube 48.3mm 4.50m</b>	16.2	<b>682022000</b>
<b>Scaffold tube 48.3mm 5.00m</b>	18.0	<b>682023000</b>
<b>Scaffold tube 48.3mm 5.50m</b>	19.8	<b>682024000</b>
<b>Scaffold tube 48.3mm 6.00m</b>	21.6	<b>682025000</b>
<b>Scaffold tube 48.3mm .....m</b> Gerüstrohr 48,3mm	3.6	<b>682001000</b>
	Galvanised	

<b>Transition swivel coupler 48/76mm</b> Übergangsdrehkupplung 48/76mm	1.9	<b>582563000</b>
	Galvanised Width-across: 22 mm Follow fitting instructions!	

<b>Swivel coupler 48mm</b> Drehkupplung 48mm	1.5	<b>582560000</b>
	Galvanised Width-across: 22 mm Follow fitting instructions!	

<b>Normal coupler 48mm</b> Normalkupplung 48mm	1.2	<b>682004000</b>
	Galvanised Width-across: 22 mm Follow fitting instructions!	

<b>Anchoring shoe for stair tower</b> Ankerschuh für Treppenturm	3.4	<b>582680000</b>
	Galvanised Length: 22 cm Width: 12 cm Height: 22 cm	

	[kg]	Article n°
<b>Cone screw B 7cm</b> Konusschraube B 7cm	0.86	<b>581444000</b>
	red Length: 10 cm Diameter: 7 cm Width-across: 50 mm	

<b>Brace stirrup 8</b> Spannbügel 8	2.7	<b>582751000</b>
	Galvanised Width: 19 cm Height: 46 cm Width-across: 30 mm	

<b>Rafter plate right</b> <b>Rafter plate left</b> Sparrenpfettenanker	0.09	<b>582521000</b>
	0.09	<b>582522000</b>
	Galvanised Length: 17 cm	

<b>Handrail clamp S</b> Schutzgeländerzwinge S	11.5	<b>580470000</b>
	Galvanised Height: 123 - 171 cm	

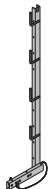
<b>Handrail post T 1.80m</b> Einschubgeländer T 1,80m	17.7	<b>584373000</b>
	Galvanised	

<b>Toeboard holder T 1.80m</b> Fußwehrhalter T 1,80m	0.53	<b>584392000</b>
	Galvanised Height: 13.5 cm	

<b>Scaffold tube connection</b> Gerüstrohranschluss	0.27	<b>584375000</b>
	Galvanised Height: 7 cm	

<b>Staxo 100 mounting gallows 40kg</b> Staxo 100-Montagegalgen 40kg	7.5	<b>582328000</b>
	Galvanised Height: 258 cm Follow the directions in the "Operating Instructions"!	<b>CE</b>

<b>Staxo 100 hoisting cable 40kg 30m</b> Staxo 100-Aufzugsseil 40kg 30m	1.3	<b>582346000</b>
		

<b>Staxo 100 attaching cable 40cm</b> Staxo 100-Anschlagseil 40cm	[kg]	Article n°	
	0.31	<b>582345000</b>	
			CE

<b>Bracing for load-bearing towers</b> Abspannung für Traggerüste	11.6	<b>582795000</b>	
			
Galvanised Painted blue			

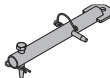
<b>Bracing waling connector WS10</b> Abspann-Riegelverbinder WS10	2.7	<b>582756000</b>	
			
Galvanised Length: 46.7 cm			

<b>Spindle connecting plate T</b> Spindellasche T	3.1	<b>584371000</b>	
			
Galvanised Width: 20 cm Height: 25 cm			

<b>Connecting pin 10cm</b> Verbindungsbolzen 10cm	0.34	<b>580201000</b>	
			
Galvanised Length: 14 cm			

<b>Spring cotter 5mm</b> Federvorstecker 5mm	0.05	<b>580204000</b>	
			
Galvanised Length: 13 cm			

<b>Lifting rod 15.0</b> Umsetzstab 15,0	1.9	<b>586074000</b>	
			
Blue Height: 57 cm Follow the directions in the "Operating Instructions"!			CE

<b>Retaining plate 15.0</b> Jochplatte 15,0	1.8	<b>586073000</b>	
			
Galvanised Length: 17 cm Width: 12 cm Height: 11 cm			

<b>Universal plug R20/25</b> Kombi-Ankerstopfen R20/25	0.003	<b>588180000</b>	
			
Blue Diameter: 3 cm			

<b>Winch 70</b> Zahnstangenwinde 70	31.0	<b>582779000</b>	
			
Painted blue Height: 126 cm Follow the directions in the "Operating Instructions"!			CE

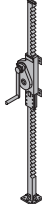
<b>Winch 125</b> Zahnstangenwinde 125	[kg]	Article n°	
	63.8	<b>582780000</b>	
			
Painted blue Height: 189 cm Follow the directions in the "Operating Instructions"!			CE

<b>Staxo/d2 adapter frame</b> Staxo/d2-Adapter	14.1	<b>582781000</b>	
			
Painted blue Length: 37 cm Width: 36 cm Height: 36 cm			

<b>Solid tire wheel</b> Voll elastikrad	34.5	<b>582573000</b>	
			
Painted blue Height: 45 cm			

<b>Heavy-duty wheel 15kN</b> Schwerlastrad 15kN	33.0	<b>582575000</b>	
			
Painted blue Height: 41 cm			

<b>Double wheeled transporter</b> Zweirad-Transportroller	5.0	<b>582558000</b>	
			
Painted blue Width: 57 cm			

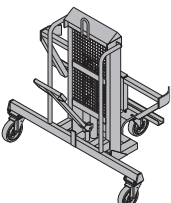
<b>Shifting carriage TG</b> Hubwagen TG	168.0	<b>582778000</b>	
			
Galvanised Length: 99 cm Width: 152 cm Height: 148 cm Follow the directions in the "Operating Instructions"!			CE

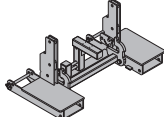
<b>Fork lift shifting device TG</b> Umsetzgerät TG für Stapler	83.0	<b>582797000</b>	
			
Galvanised Length: 60 cm Width: 113 cm Height: 52 cm Follow the directions in the "Operating Instructions"!			CE

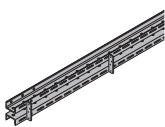
<b>Multi-purpose waling WS10 Top50 2.00m</b> Mehrzweckriegel WS10 Top50 2,00m	38.9	<b>580007000</b>	
			
Painted blue			

[kg] Article n°

[kg] Article n°

**Doka personal fall-arrest set**  
Doka-Auffanggurt

3.6 **583022000**



Follow the directions in the  
"Operating Instructions"!

