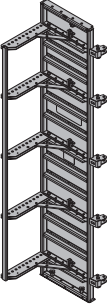
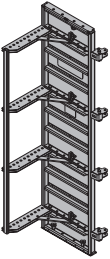
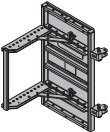
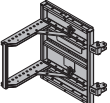
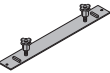

	[kg]	Art.-Nr.
Xlife-Element KS 3,30m Xlife panel KS 3.30m	185,0	580346500
 verzinkt Breite: 80 cm Lieferzustand: zusammengeklappt		

Xlife-Element KS 2,70m Xlife panel KS 2.70m	140,0	580337500
 verzinkt Breite: 80 cm Lieferzustand: zusammengeklappt		

Xlife-Element KS 1,20m Xlife panel KS 1.20m	66,0	580338500
 verzinkt Breite: 80 cm Lieferzustand: zusammengeklappt		

Xlife-Element KS 0,90m Xlife panel KS 0.90m	56,0	580339500
 verzinkt Breite: 80 cm Lieferzustand: zusammengeklappt		

Schutzleiste KS Protective plate KS	3,3	580343000
 verzinkt Länge: 70 cm Breite: 9 cm		

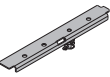
Schutzleiste KS oben Protective plate KS top	3,0	580357000
 verzinkt Länge: 65,3 cm Breite: 8,4 cm		

Verschlusshaken KS Locking hook KS	0,83	580344000
 verzinkt Länge: 31 cm		

Superplatte 15,0 Super plate 15.0	1,1	581966000
 verzinkt Höhe: 6 cm Durchmesser: 12 cm Schlüsselweite: 27 mm		

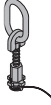

	[kg]	Art.-Nr.
Umsetzring Lifting ring	1,4	580340000
 verzinkt Höhe: 20 cm		

Aufstockschraube KS Stacking screw KS	0,77	580345000
 verzinkt Höhe: 20 cm		

Stirndreikanteleiste KS 20 4,00m Stirndreikanteleiste KS 15 4,00m Frontal triangular ledge KS	0,93 0,71	580347000 580359000
 grau		

Framax-Dreikanteleiste 2,70m Framax triangular ledge 2.70m	0,38	588170000
		

Elementstütze 340 IB Panel strut 340 IB bestehend aus:	24,3	580365000
(A) Justierstütze 340 IB verzinkt Länge: 190,8 - 341,8 cm	16,7	588696000
(B) Justierstrebe 120 IB verzinkt Länge: 81,5 - 130,6 cm	7,6	588248500

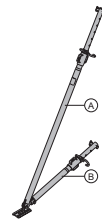

verzinkt
Lieferzustand: zusammengeklappt

Elementstütze 540 IB Panel strut 540 IB bestehend aus:	41,4	580366000
(A) Justierstütze 540 IB verzinkt Länge: 310,5 - 549,2 cm	30,7	588697000
(B) Justierstrebe 220 IB verzinkt Länge: 172,5 - 221,1 cm	10,9	588251500

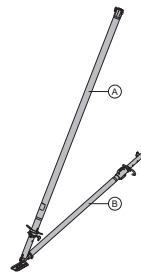



verzinkt
Lieferzustand: zusammengeklappt

Stützenkopf KS EB Prop head KS EB	0,85	580342000
 verzinkt Länge: 14 cm Breite: 11 cm Höhe: 14 cm		

	[kg]	Art.-Nr.
Universal-Lösewerkzeug Universal dismantling tool	3,7	582768000
	verzinkt Länge: 75,5 cm	

Doka-Expressanker 16x125mm Doka express anchor 16x125mm	0,31	588631000
	verzinkt Länge: 18 cm Einbauanleitung beachten!	

Doka-Coil 16mm Doka coil 16mm	0,009	588633000
	verzinkt Durchmesser: 1,6 cm	

Lehre Doka-Expressanker 16x125mm Gauge for Doka express anchor 16x125mm	0,03	588632000
	schwarz Länge: 3 cm Durchmesser: 2 cm	

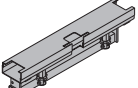
Bühnenanschluss KS Platform adapter KS	11,4	580341000
	verzinkt Länge: 74 cm Breite: 12 cm Höhe: 20 cm	

Doka-Stützenbühne 150/90cm Doka column formwork platform 150/90cm	211,8	588382000
	verzinkt Länge: 173 cm Breite: 173 cm Höhe: 130 cm Lieferzustand: zusammengeklappt	

Gegengeländer Stützenbühne 150/90cm Counter railing col. formwork plat. 150/90cm	8,0	588385000
	verzinkt Breite: 87 cm Höhe: 170 cm	

Fertigbelag KS Platform planking KS	32,3	580360000
	Holzteile gelb lasiert Stahlteile verzinkt Länge: 90 cm Breite: 85 cm	

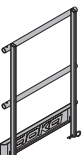
Fertiggeländer KS 1,00x0,85m Railing KS 1.00x0.85m	12,4	580363000
	verzinkt	

	[kg]	Art.-Nr.
Gegengeländer Fertigbelag KS Counter railing platform planking KS	7,4	580361000
	verzinkt Breite: 91,6 cm Höhe: 170 cm	

Seitengeländer KS 0,30m Side railing KS 0.30m	2,6	580364000
	verzinkt Länge: 38 cm Breite: 30 cm Höhe: 53 cm	

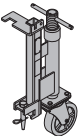
Umsetzrad KS Shifting wheel KS	15,8	580358000
	verzinkt Betriebsanleitung beachten!	CE

Doka-Vierstrangkette 3,20m Doka 4-part chain 3.20m	15,0	588620000
	Betriebsanleitung beachten!	CE

Verbindungsbolzen 10cm Connecting pin 10cm	0,34	580201000
	verzinkt Länge: 14 cm	