

	[kg]	Art.-Nr.
Grundgestell Schalwagen TS Bogie for forming wagon TS bestehend aus:	936,0	584336000
(A) Horizontalrahmen Schalwagen T	505,0	584337000
(B) Vertikalrahmen Schalwagen T	177,0	584338000
(C) Rahmenstrebe Schalwagen T 2 Stk.	13,5	584339000
(D) Spindelstrebe GS T6 95/140cm 2 Stk. verzinkt	10,3	584340000
(E) Spurkranzrad T 4 Stk.	51,0	584341000

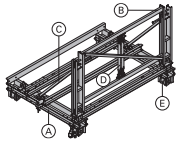

verzinkt
Länge: 330 cm
Breite: 229 cm
Höhe: 214 cm
Lieferzustand: zusammengeklappt

Ausleger Schalwagen T Double jib for forming wagon T bestehend aus:	357,0	584342000
(A) Auslegerrahmen Schalwagen T	295,0	584343000
(B) Auslegerschlitten Schalwagen T verzinkt Länge: 64,4-102,2 cm	63,0	584344000

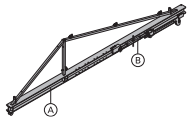

verzinkt
Länge: 580 cm
Höhe: 127 cm

Spindelstrebe T7 75/110cm Spindle strut T7 75/110cm	13,2	584308000
---	------	------------------

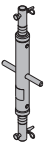

verzinkt

Spindelstrebe T7 100/150cm Spindle strut T7 100/150cm	16,8	584309000
---	------	------------------

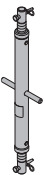

verzinkt

Spindelstrebe T7 150/200cm Spindle strut T7 150/200cm	21,6	584324000
---	------	------------------

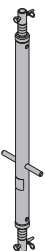

verzinkt

	[kg]	Art.-Nr.
Spindelstrebe GS T7 109/166cm Spindle strut GS T7 109/166cm	21,6	584345000

verzinkt

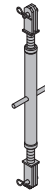

Spindelstrebe T6 73/110cm Spindle strut T6 73/110cm	10,2	584355000
---	------	------------------

verzinkt

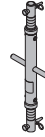

Spindelstrebe T6 100/150cm Spindle strut T6 100/150cm	12,5	584323000
---	------	------------------

verzinkt



Druckstütze T Pressure prop T	37,7	584349000
---	------	------------------

verzinkt
Höhe: 194 cm

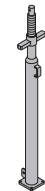

Hängeträger Schalwagen T Suspension beam for forming wagon T	175,0	584346000
--	-------	------------------

verzinkt
Höhe: 352 cm

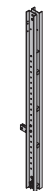

Längsträger Schalwagen T Longitudinal beam for forming wagon T	36,0	584351000
--	------	------------------

verzinkt
Länge: 301 cm



Fertigbühne Schalwagen T Pre-assembly platform for forming wagon T	347,5	584347000
--	-------	------------------

Holzteile gelb lasiert
Stahlteile verzinkt
Länge: 490 cm
Breite: 170 cm

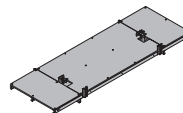

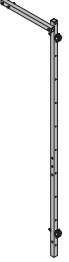
	[kg]	Art.-Nr.
Geländerstreben Schalwagen T Railing strut for forming wagon T	18,0	584348000
 verzinkt Höhe: 300 cm Lieferzustand: zusammengelegt		

Geländerholm T 0,70m Handrail post T 0.70m	2,8	584353000
 verzinkt Höhe: 86,6 cm		

Schutzgeländerzwinge S Handrail clamp S	11,5	580470000
 verzinkt Höhe: 123 - 171 cm		

Hängeträgerverlängerung T 1,00m Suspension beam extension T 1.00m	89,5	584361000
 verzinkt Höhe: 143 cm		

Bühnenverbreiterung T Platform extension plate T	24,0	584362000
 verzinkt Breite: 95 cm Höhe: 36 cm Lieferzustand: Seil zusammengerollt		

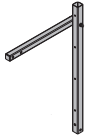
Geländerverlängerung T 1,00m Handrail extension T 1.00m	9,8	584363000
 verzinkt		

Stabilisierungslasche T Stabilising plate T	2,5	584367000
 verzinkt Länge: 13 cm Breite: 12 cm Höhe: 8 cm		

	[kg]	Art.-Nr.
Anhängelasche T Slings plate T	8,3	584368000
 verzinkt Länge: 28 cm Breite: 14 cm Höhe: 8 cm		

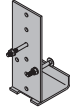
Bühnenauflage T Attachable platform support T	2,5	584369000
 verzinkt Länge: 12,6 cm Breite: 11 cm Höhe: 29,6 cm		

Fertiggeländer T oben Railing T top	86,0	584376000
 Stahlteile verzinkt Holzteile gelb lasiert Länge: 490 cm Höhe: 156 cm		

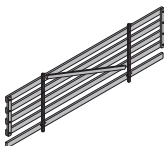
Fertiggeländer T unten Railing T bottom	98,0	584377000
 Stahlteile verzinkt Holzteile gelb lasiert Länge: 490 cm Höhe: 156 cm		

Justierspindel T Adjusting spindle T	17,1	584374000
 verzinkt Höhe: 96 cm		

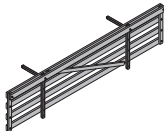
Aufsatzgeländer T Vertical extension rail T	107,0	584378000
 Stahlteile verzinkt Holzteile gelb lasiert Länge: 490 cm Höhe: 120 cm		

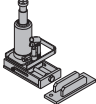
Justiereinrichtung für Schalwagen T Adjusting device for forming wagon T	22,9	584383000
 blau lackiert Höhe: 28,5-55,2 cm		

Verbindungsbolzen 10cm Connecting pin 10cm	0,34	580201000
 verzinkt Länge: 14 cm		

Federvorstecker 5mm Spring cotter 5mm	0,05	580204000
 verzinkt Länge: 13 cm		