

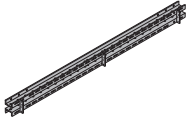

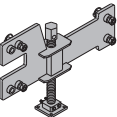

	[kg]	Art.-Nr.
Fassadenriegel WS10 2,50m	50,0	580692000
Fassadenriegel WU14 6,00m	189,2	580691000
Facade waling		
		blau lackiert

Fassaden-Fertigteilklemme H	26,2	580693000
Facade precast member clamp H		
		verzinkt Länge: 70 cm Höhe: 41 cm Schlüsselweite: 50 mm

Fassaden-Fertigteilklemme V	8,1	580694000
Facade precast member clamp V		
		verzinkt Länge: 70 cm Höhe: 41 cm Schlüsselweite: 50 mm

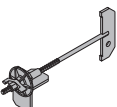
Fassaden-Fertigteilklemme O	4,9	580698000
Facade precast member clamp O		
		verzinkt Länge: 59 cm Höhe: 22 cm

Fassaden-Riegelverbinder	4,7	580695000
Facade waling connector		
		verzinkt Länge: 26 cm Höhe: 25 cm

Fassaden-Ankermuffe 15,0	3,5	580696000
Facade anchor socket 15.0		
		verzinkt Länge: 33 cm Breite: 12 cm

Ösenanker 15,0 ohne Ankerstab	1,2	580649000
Eye-lug anchor 15.0 without tie rod		
		verzinkt Länge: 11 cm

Mehrweckriegel WS10 Top50 0,50m	10,2	580001000
Mehrweckriegel WS10 Top50 0,75m	14,9	580002000
Mehrweckriegel WS10 Top50 1,00m	19,6	580003000
Mehrweckriegel WS10 Top50 1,25m	24,7	580004000
Mehrweckriegel WS10 Top50 2,50m	48,7	580009000
Multi-purpose waling WS10 Top50		
		blau lackiert

Mehrweckriegel WU12 Top50 1,50m	37,5	580020000
Multi-purpose waling WU12 Top50 1.50m		
		blau lackiert

	[kg]	Art.-Nr.
Flanschklammer H20	1,0	580135000
Flange clamp H20		
		verzinkt Breite: 13 cm Schlüsselweite: 19 mm

Stirnschuh H20	0,36	587248000
Protective cap H20		
		verzinkt Länge: 20 cm Breite: 7 cm

Kranöse	6,2	580460000
Lifting bracket		
		verzinkt Höhe: 59 cm

Winkellasche 90/50	13,8	580603000
Corner connecting plate 90/50		
		blau lackiert Länge: 51 cm Breite: 40 cm

Universal-Winkelspanner	4,4	580604000
Universal angle tie bracket		
		blau lackiert Länge: 20 cm

Verbindungsbolzen 10cm	0,34	580201000
Connecting pin 10cm		
		verzinkt Länge: 14 cm

Federvorstecker 5mm	0,05	580204000
Spring cotter 5mm		
		verzinkt Länge: 13 cm

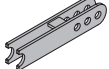
Fassaden-Riegelhalter	2,3	580674000
Facade waling holder		
		verzinkt Länge: 31 cm

Fassaden-Stützenhalter	2,0	580675000
Facade strut holder		
		verzinkt Länge: 30 cm

Justierstütze 340 IB	16,7	588696000
Plumbing strut 340 IB		
		verzinkt Länge: 190,8 - 341,8 cm

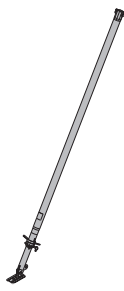
	[kg]	Art.-Nr.
Justierstütze 540 IB Plumbing strut 540 IB	30,7	588697000
 verzinkt Länge: 310,5 - 549,2 cm		

Strebenschuh EB Strut shoe EB	0,93	588946000
 verzinkt Breite: 8 cm Höhe: 13 cm		

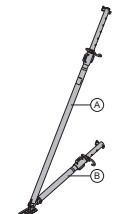
Elementstütze 340 IB Panel strut 340 IB bestehend aus:	24,3	580365000
(A) Justierstütze 340 IB verzinkt Länge: 190,8 - 341,8 cm	16,7	588696000
(B) Justierstrebe 120 IB verzinkt Länge: 81,5 - 130,6 cm	7,6	588248500
 verzinkt Lieferzustand: zusammengeklappt		

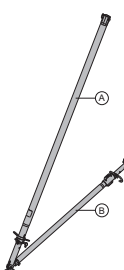
Elementstütze 540 IB Panel strut 540 IB bestehend aus:	41,4	580366000
(A) Justierstütze 540 IB verzinkt Länge: 310,5 - 549,2 cm	30,7	588697000
(B) Justierstrebe 220 IB verzinkt Länge: 172,5 - 221,1 cm	10,9	588251500
 verzinkt Lieferzustand: zusammengeklappt		

Stützenkopf EB Prop head EB	3,1	588244500
 verzinkt Länge: 40,8 cm Breite: 11,8 cm Höhe: 17,6 cm		

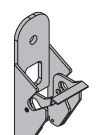
Andockkopf Docking head	3,3	588690000
 verzinkt Länge: 29,5 cm		

Andockset Docking set	0,66	588694000
 verzinkt Länge: 16 cm		

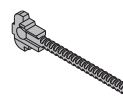
Andockschraube Docking screw	0,60	588698000
 verzinkt Länge: 30,5 cm		

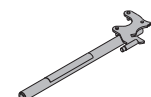
Universal-Löswerkzeug Universal dismantling tool	3,7	582768000
 verzinkt Länge: 75,5 cm		

Doka-Expressanker 16x125mm Doka express anchor 16x125mm	0,31	588631000
 verzinkt Länge: 18 cm Einbauanleitung beachten!		

Doka-Coil 16mm Doka coil 16mm	0,009	588633000
 verzinkt Durchmesser: 1,6 cm		

Lehre Doka-Expressanker 16x125mm Gauge for Doka express anchor 16x125mm	0,03	588632000
 schwarz Länge: 3 cm Durchmesser: 2 cm		

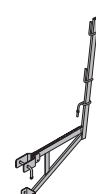
Betonierkonsole L Top scaffold bracket L	12,6	587153500
 verzinkt Länge: 101 cm Höhe: 159 cm		

Universal-Konsole 60 Universal bracket 60	14,0	580477000
 verzinkt Länge: 86 cm Höhe: 181 cm		

Universal-Konsole 90 Universal bracket 90	30,4	580476000
 verzinkt Länge: 121 cm Höhe: 235 cm		

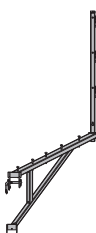
	[kg]	Art.-Nr.
Universal-Eckkonsole 90 rechts	29,5	580071000
Universal-Eckkonsole 90 links	29,5	580070000
Universal corner bracket 90		
	verzinkt	
	Länge: 152 cm	
	Höhe: 235 cm	

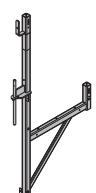
Hohlwand-Konsole 60	18,9	583033000
Cavity wall bracket 60		
	verzinkt	
	Länge: 73 cm	
	Höhe: 174 cm	

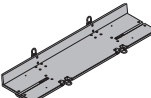
Konsolenbelag 60/250cm	48,5	583029000
Konsolenbelag 60/270cm	52,5	583030000
Konsolenbelag 90/250cm	61,3	583031000
Bracket planking		
	Stahlteile verzinkt	
	Holzteile gelb lasiert	

Konsolengeländer 240-270cm	22,5	583032000
Bracket railing 240-270cm		
	verzinkt	

Universal-Geländerbügel	3,0	580478000
Universal railing shackle		
	verzinkt	
	Höhe: 20 cm	

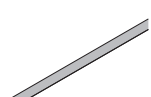
Gerüstrohr 48,3mm 0,50m	1,7	682026000
Gerüstrohr 48,3mm 1,00m	3,6	682014000
Gerüstrohr 48,3mm 1,50m	5,4	682015000
Gerüstrohr 48,3mm 2,00m	7,2	682016000
Gerüstrohr 48,3mm 2,50m	9,0	682017000
Gerüstrohr 48,3mm 3,00m	10,8	682018000
Gerüstrohr 48,3mm 3,50m	12,6	682019000
Gerüstrohr 48,3mm 4,00m	14,4	682021000
Gerüstrohr 48,3mm 4,50m	16,2	682022000
Gerüstrohr 48,3mm 5,00m	18,0	682023000
Gerüstrohr 48,3mm 5,50m	19,8	682024000
Gerüstrohr 48,3mm 6,00m	21,6	682025000
Gerüstrohr 48,3mmm	3,6	682001000
Scaffold tube 48.3mm		
	verzinkt	

Gerüstrohranschluss	0,27	584375000
Scaffold tube connection		
	verzinkt	
	Höhe: 7 cm	

	[kg]	Art.-Nr.
Schutzgeländerzwinde S	11,5	580470000
Handrail clamp S		
	verzinkt	
	Höhe: 123 - 171 cm	

Schutzgeländer 1,10m	5,5	584384000
Handrail post 1.10m		
	verzinkt	
	Höhe: 134 cm	

Steckhülse 24mm	0,03	584385000
Attachable sleeve 24mm		
	grau	
	Länge: 16,5 cm	
	Durchmesser: 2,7 cm	

Schraubhülse 20,0	0,03	584386000
Screw sleeve 20.0		
	gelb	
	Länge: 20 cm	
	Durchmesser: 3,1 cm	

Anschraubkupplung 48mm 50	0,84	682002000
Anschraubkupplung 48mm 95	0,88	586013000
Screw-on coupler		
	verzinkt	
	Schlüsselweite: 22 mm	
	Einbauanleitung beachten!	

Drehkupplung 48mm	1,5	582560000
Swivel coupler 48mm		
	verzinkt	
	Schlüsselweite: 22 mm	
	Einbauanleitung beachten!	

Normalkupplung 48mm	1,2	682004000
Normal coupler 48mm		
	verzinkt	
	Schlüsselweite: 22 mm	
	Einbauanleitung beachten!	

Doka-Vierstrangkette 3,20m	15,0	588620000
Doka 4-part chain 3.20m		
	Betriebsanleitung beachten!	



	[kg]	Art.-Nr.
GF-Werkzeugbox Tool box GF	6,5	580390000
Im Lieferumfang enthalten:		
(A) Umschaltknarre 1/2" verzinkt Länge: 30 cm	0,73	580580000
(B) Gabelschlüssel 13/17	0,08	580577000
(C) Gabelschlüssel 22/24	0,22	580587000
(D) Gabelschlüssel 30/32	0,80	580897000
(E) Ringschlüssel 17/19	0,27	580590000
(F) Verlängerung 11cm 1/2"	0,20	580581000
(G) Verlängerung 22cm 1/2"	0,31	580582000
(H) Kardangelenk 1/2"	0,16	580583000
(I) Stecknuss 19 1/2" L	0,16	580598000
(J) Stecknuss 13 1/2"	0,06	580576000
(K) Stecknuss 24 1/2"	0,12	580584000
(L) Stecknuss 30 1/2"	0,20	580575000

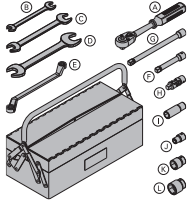

Umschaltknarre 3/4" Reversible ratchet 3/4"	1,5	580894000
---	-----	------------------

verzinkt
Länge: 50 cm

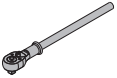

Stecknuss 50 3/4" Box nut 50 3/4"	0,81	581449000
---	------	------------------



Freilaufknarre SW27 Friction type ratchet SW27	0,49	581855000
--	------	------------------

manganphosphatiert
Länge: 30 cm

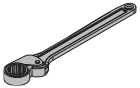

Steckschlüssel 27 0,65m Box spanner 27 0.65m	1,9	581854000
--	-----	------------------

verzinkt

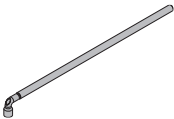

Anhängewinkel Typ A Tie-off connector type A	0,96	581641000
--	------	------------------

verzinkt
Länge: 13,7 cm



Doka-Auffanggurt Doka personal fall-arrest set	3,6	583022000
--	-----	------------------

Betriebsanleitung beachten!

