

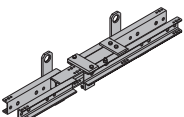
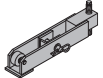

|  | [kg]     | Art.-Nr.         |
|--|----------|------------------|
| <b>Teleskop-Schachträger 1,45-1,65m</b>  | 65,9     | <b>580686000</b> |
| <b>Teleskop-Schachträger 1,65-2,00m</b>  | 74,3     | <b>580687000</b> |
| <b>Teleskop-Schachträger 2,00-2,70m</b>  | 107,5    | <b>580688000</b> |
| <b>Teleskop-Schachträger 2,70-3,80m</b>  | 156,5    | <b>580689000</b> |
| <b>Teleskop-Schachträger 3,80-5,90m</b>  | 261,0    | <b>580690000</b> |
| Telescopic shaft beam  |          |                  |
|  | verzinkt |                  |

|  |                       |                  |
|--|-----------------------|------------------|
| <b>Klinke für Schachtbühne</b>   | 18,0                  | <b>580466000</b> |
| Latch for shaft platform   |                       |                  |
|  | verzinkt              |                  |
|  | Länge: 55 cm          |                  |
|  | Schlüsselweite: 19 mm |                  |

|  |                        |                  |
|--|------------------------|------------------|
| <b>Aussparungskasten 20x20x15cm</b>  | 2,6                    | <b>580608000</b> |
| Box for latch 20x20x15cm   |                        |                  |
|  | blau pulverbeschichtet |                  |

|   |                     |                  |
|---|---------------------|------------------|
| <b>Verschlussstopfen 15,0</b>   | 0,001               | <b>580609000</b> |
| Plug 15.0   |                     |                  |
|  | farblos             |                  |
|   | Durchmesser: 1,9 cm |                  |

|  |               |                  |
|--|---------------|------------------|
| <b>Bühnenkopf</b>  | 14,9          | <b>580464000</b> |
| Main beam head   |               |                  |
|  | blau lackiert |                  |
|  | Länge: 49 cm  |                  |

|                                   |      |                  |
|-----------------------------------|------|------------------|
| <b>GF-Werkzeugbox</b>             | 6,5  | <b>580390000</b> |
| Tool box GF                       |      |                  |
| Im Lieferumfang enthalten:        |      |                  |
| (A) <b>Umschaltknarre 1/2"</b>    | 0,73 | <b>580580000</b> |
| verzinkt                          |      |                  |
| Länge: 30 cm                      |      |                  |
| (B) <b>Gabelschlüssel 13/17</b>   | 0,08 | <b>580577000</b> |
| (C) <b>Gabelschlüssel 22/24</b>   | 0,22 | <b>580587000</b> |
| (D) <b>Gabelschlüssel 30/32</b>   | 0,80 | <b>580897000</b> |
| (E) <b>Ringschlüssel 17/19</b>    | 0,27 | <b>580590000</b> |
| (F) <b>Verlängerung 11cm 1/2"</b> | 0,20 | <b>580581000</b> |
| (G) <b>Verlängerung 22cm 1/2"</b> | 0,31 | <b>580582000</b> |
| (H) <b>Kardangeln 1/2"</b>        | 0,16 | <b>580583000</b> |
| (I) <b>Stecknuss 19 1/2" L</b>    | 0,16 | <b>580598000</b> |
| (J) <b>Stecknuss 13 1/2"</b>      | 0,06 | <b>580576000</b> |
| (K) <b>Stecknuss 24 1/2"</b>      | 0,12 | <b>580584000</b> |
| (L) <b>Stecknuss 30 1/2"</b>      | 0,20 | <b>580575000</b> |

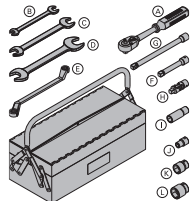

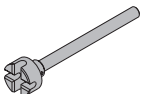
|  |                   |                  |
|--|-------------------|------------------|
| <b>Ankerstabschlüssel 15,0/20,0</b>  | 1,9               | <b>580594000</b> |
| Tie-rod wrench 15.0/20.0   |                   |                  |
|  | verzinkt          |                  |
|  | Länge: 37 cm      |                  |
|  | Durchmesser: 8 cm |                  |

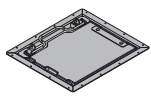
|  | [kg]                   | Art.-Nr.         |
|--|------------------------|------------------|
| <b>Bühnendurchstieg B 70/60cm</b>  | 22,0                   | <b>581530000</b> |
| Manhole B 70/60cm  |                        |                  |
|  | Stahlteile verzinkt    |                  |
|  | Holzteile gelb lasiert |                  |
|  | Länge: 81 cm           |                  |
|  | Breite: 71 cm          |                  |

|   |          |                  |
|---|----------|------------------|
| <b>System-Leiter XS 4,40m</b>   | 33,2     | <b>588640000</b> |
| System ladder XS 4.40m  |          |                  |
|  | verzinkt |                  |

|   |             |                  |
|---|-------------|------------------|
| <b>Leiternfuß XS</b>  | 5,0         | <b>588673000</b> |
| Ladder adapter XS   |             |                  |
|  | verzinkt    |                  |
|   | Höhe: 50 cm |                  |