



	[kg]	Art.-Nr.
Horizontalprofil MF mit Geländer Horizontal profile MF with handrail post	88,5	581618000
 verzinkt Länge: 251 cm Höhe: 155 cm		

Vertikalprofil MF80 Vertical profile MF80	44,0	580652000
 verzinkt Höhe: 213 cm		

Vertikalprofil MF160 Vertical profile MF160	93,3	580660000
 verzinkt Höhe: 208 cm		

Druckstrebe MF lang Pressure strut MF long	24,7	580653000
 verzinkt Länge: 252,9 cm		

Druckstrebe MF kurz Pressure strut MF short	17,7	580654000
 verzinkt Länge: 183,2 cm		

Druckspindel MF240 Pressure spindle MF240	26,0	580680000
 verzinkt Höhe: 166 - 226 cm		

Fahrwerk MF Travelling gear MF	32,3	580656000
 verzinkt Länge: 128 cm Höhe: 22 cm		

	[kg]	Art.-Nr.
Einrichtungsspindel MF 3,00m Plumbing spindle MF 3.00m	23,0	580657000
 Länge: 166-229 cm		

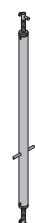
Einrichtungsspindel MF 4,50m Plumbing spindle MF 4.50m	46,0	580664000
 verzinkt Länge: 262 - 345 cm		

Fahrriegel MF 3,00m Vertical waling MF 3.00m	76,8	580658000
 verzinkt		

Fahrriegel MF 4,50m Vertical waling MF 4.50m	123,8	580663000
 verzinkt		

Fahrriegelverlängerung MF Vertical waling extension MF	41,5	580659000
 verzinkt Höhe: 144 cm		

Hängeprofil MF Suspension profile MF	43,0	580668000
 Höhe: 368 cm		

	[kg]	Art.-Nr.
Anschraubühne MF75 Screw-on access bracket MF75	19,0	580669000
	verzinkt Länge: 113 cm Höhe: 152 cm	

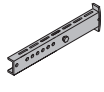
Distanzprofil MF Distance profile MF	7,8	580670000
	Länge: 71 cm	

Schwenkplatte MF Swivel plate MF	4,5	580672000
	verzinkt Länge: 29 cm Höhe: 20 cm	

Spannbügel 8 Brace stirrup 8	2,7	582751000
	verzinkt Breite: 19 cm Höhe: 46 cm Schlüsselweite: 30 mm	

Sicherungsblech für Spannbügel 8 Safety plate for brace stirrup 8	0,05	582753000
	rot Länge: 23 cm	

Grundblockriegel MF Starter block unit MF	23,2	580678000
	verzinkt Länge: 143 cm Breite: 19 cm	

Windabspannung MF/150F/K 6,00m Wind bracing MF/150F/K 6.00m	4,7	580665000
	verzinkt	

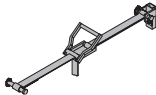
Windabspannung MF 6,00m Wind bracing MF 6.00m	4,3	580677000
	verzinkt	

Riegelhalter 9-15cm Waling-to-bracket holder 9-15cm	2,7	580625000
	verzinkt	

Keilriegelhalter Waling-to-bracket holder	2,5	580526000
	verzinkt Länge: 26 cm Höhe: 31 cm	

	[kg]	Art.-Nr.
Geländerzwinge XP 40cm Railing clamp XP 40cm	7,7	586456000
	verzinkt Höhe: 73 cm	

Geländersteher XP 1,20m Handrail post XP 1.20m	4,1	586460000
	verzinkt Höhe: 118 cm	

Fußwehrhalter XP 1,20m Toeboard holder XP 1.20m	0,64	586461000
	verzinkt Höhe: 21 cm	

Schutzgeländerzwinge S Handrail clamp S	11,5	580470000
	verzinkt Höhe: 123 - 171 cm	

Universal-Geländerbügel Universal railing shackle	3,0	580478000
	verzinkt Höhe: 20 cm	

Doka-Vierstrangkette 3,20m Doka 4-part chain 3.20m	15,0	588620000
	Betriebsanleitung beachten!	CE

Umsetzbalken 110kN 6,00m Lifting beam 110kN 6.00m	136,5	586359000
	verzinkt Länge: 626 cm Betriebsanleitung beachten!	CE

	[kg]	Art.-Nr.
Gerüstrohr 48,3mm 0,50m	1,7	682026000
Gerüstrohr 48,3mm 1,00m	3,6	682014000
Gerüstrohr 48,3mm 1,50m	5,4	682015000
Gerüstrohr 48,3mm 2,00m	7,2	682016000
Gerüstrohr 48,3mm 2,50m	9,0	682017000
Gerüstrohr 48,3mm 3,00m	10,8	682018000
Gerüstrohr 48,3mm 3,50m	12,6	682019000
Gerüstrohr 48,3mm 4,00m	14,4	682021000
Gerüstrohr 48,3mm 4,50m	16,2	682022000
Gerüstrohr 48,3mm 5,00m	18,0	682023000
Gerüstrohr 48,3mm 5,50m	19,8	682024000
Gerüstrohr 48,3mm 6,00m	21,6	682025000
Gerüstrohr 48,3mmm	3,6	682001000
Scaffold tube 48.3mm		

verzinkt

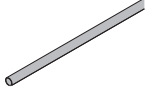

Anschraubkupplung 48mm 50	0,84	682002000
Anschraubkupplung 48mm 95	0,88	586013000
Screw-on coupler		

verzinkt

Schlüsselweite: 22 mm

Einbauanleitung beachten!

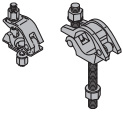

Drehkupplung 48mm	1,5	582560000
Swivel coupler 48mm		

verzinkt

Schlüsselweite: 22 mm

Einbauanleitung beachten!



Verbotsschild "Zutritt Verboten" 300x300mm	0,70	581575000
Warning sign "No entry" 300x300mm		



Doka-Auffanggurt	3,6	583022000
Doka personal fall-arrest set		

Betriebsanleitung beachten!



GF-Werkzeugbox	6,5	580390000
Tool box GF		

Im Lieferumfang enthalten:

(A) Umschaltknarre 1/2"	0,73	580580000
verzinkt		
Länge: 30 cm		
(B) Gabelschlüssel 13/17	0,08	580577000
(C) Gabelschlüssel 22/24	0,22	580587000
(D) Gabelschlüssel 30/32	0,80	580897000
(E) Ringschlüssel 17/19	0,27	580590000
(F) Verlängerung 11cm 1/2"	0,20	580581000
(G) Verlängerung 22cm 1/2"	0,31	580582000
(H) Kardangelen 1/2"	0,16	580583000
(I) Stecknuss 19 1/2" L	0,16	580598000
(J) Stecknuss 13 1/2"	0,06	580576000
(K) Stecknuss 24 1/2"	0,12	580584000
(L) Stecknuss 30 1/2"	0,20	580575000

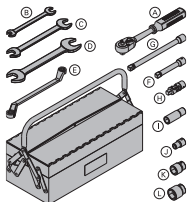

	[kg]	Art.-Nr.
--	------	----------

Zusatzwerkzeuge MF

Additional tools MF

bestehend aus:

(A) Umschaltknarre 3/4"	1,5	580894000
verzinkt		
Länge: 50 cm		
(B) Stecknuss 17 1/2"	0,07	580685000
(C) Stecknuss 50 3/4"	0,81	581449000
(D) Verlängerung 20cm 3/4"	0,68	580683000
(E) Übergangsteil A 1/2"x3/4"	0,18	580684000
(F) Universal-Konusschlüssel 15,0/20,0	0,90	581448000
verzinkt		
Länge: 9 cm		
Schlüsselweite: 50 mm		

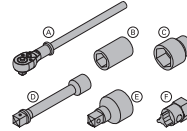

Montagewerkzeug Schalhautschutz	0,96	580222000
Mounting tool for form-ply protector		

verzinkt

Breite: 12 cm

Höhe: 12 cm

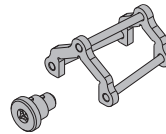

Stecknuss 24 1/2" L	0,30	586364000
Box nut 24 1/2" L		



Ring-Maulschlüssel 24	0,25	582839000
Combination wrench 24		



Antriebsknarre MF 3/4" SW50	3,8	580648000
Ratchet MF 3/4" SW50		

verzinkt

