

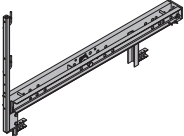





	[kg]	Article n°
<b>Horizontal profile MF with handrail post</b> Horizontalprofil MF mit Geländer	88.5	<b>581618000</b>
 Galvanised Length: 251 cm Height: 155 cm		

<b>Vertical profile MF80</b> Vertikalprofil MF80	44.0	<b>580652000</b>
 Galvanised Height: 213 cm		

<b>Vertical profile MF160</b> Vertikalprofil MF160	93.3	<b>580660000</b>
 Galvanised Height: 208 cm		

<b>Pressure strut MF long</b> Druckstrebe MF lang	24.7	<b>580653000</b>
 Galvanised Length: 252.9 cm		

<b>Pressure strut MF short</b> Druckstrebe MF kurz	17.7	<b>580654000</b>
 Galvanised Length: 183.2 cm		

<b>Pressure spindle MF240</b> Druckspindel MF240	26.0	<b>580680000</b>
 Galvanised Height: 166 - 226 cm		

<b>Travelling gear MF</b> Fahrwerk MF	32.3	<b>580656000</b>
 Galvanised Length: 128 cm Height: 22 cm		

	[kg]	Article n°
<b>Plumbing spindle MF 3.00m</b> Einrichtspindel MF 3,00m	23.0	<b>580657000</b>
 Length: 166-229 cm		

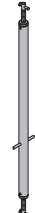
<b>Plumbing spindle MF 4.50m</b> Einrichtspindel MF 4,50m	46.0	<b>580664000</b>
 Galvanised Length: 262 - 345 cm		

<b>Vertical waling MF 3.00m</b> Fahrriegel MF 3,00m	76.8	<b>580658000</b>
 Galvanised		

<b>Vertical waling MF 4.50m</b> Fahrriegel MF 4,50m	123.8	<b>580663000</b>
 Galvanised		

<b>Vertical waling extension MF</b> Fahrriegelverlängerung MF	41.5	<b>580659000</b>
 Galvanised Height: 144 cm		

<b>Suspension profile MF</b> Hängeprofil MF	43.0	<b>580668000</b>
 Height: 368 cm		

	[kg]	Article n°
<b>Screw-on access bracket MF75</b> Anschraubbühne MF75	19.0	<b>580669000</b>
	Galvanised	Length: 113 cm Height: 152 cm

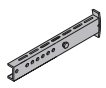
<b>Distance profile MF</b> Distanzprofil MF	7.8	<b>580670000</b>
	Galvanised	Length: 71 cm

<b>Swivel plate MF</b> Schwenkplatte MF	4.5	<b>580672000</b>
	Galvanised	Length: 29 cm Height: 20 cm

<b>Brace stirrup 8</b> Spannbügel 8	2.7	<b>582751000</b>
	Galvanised	Width: 19 cm Height: 46 cm Width-across: 30 mm

<b>Safety plate for brace stirrup 8</b> Sicherungsblech für Spannbügel 8	0.05	<b>582753000</b>
	red	Length: 23 cm

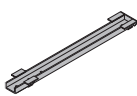
<b>Starter block unit MF</b> Grundblockriegel MF	23.2	<b>580678000</b>
	Galvanised	Length: 143 cm Width: 19 cm

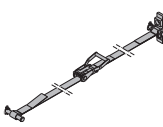
<b>Wind bracing MF/150F/K 6.00m</b> Windabspannung MF/150F/K 6,00m	4.7	<b>580665000</b>
	Galvanised	

<b>Waling-to-bracket holder 9-15cm</b> Riegelhalter 9-15cm	2.7	<b>580625000</b>
	Galvanised	

<b>Railing clamp XP 40cm</b> Geländerzwinge XP 40cm	7.7	<b>586456000</b>
	Galvanised	Height: 73 cm

	[kg]	Article n°
<b>Handrail post XP 1.20m</b> Geländersteher XP 1,20m	4.1	<b>586460000</b>
	Galvanised	Height: 118 cm

<b>Toeboard holder XP 1.20m</b> Fußwehrhalter XP 1,20m	0.64	<b>586461000</b>
	Galvanised	Height: 21 cm

<b>Handrail clamp S</b> Schutzgeländerzwinge S	11.5	<b>580470000</b>
	Galvanised	Height: 123 - 171 cm

<b>Universal railing shackle</b> Universal-Geländerbügel	3.0	<b>580478000</b>
	Galvanised	Height: 20 cm

<b>Doka 4-part chain 3.20m</b> Doka-Vierstrangkette 3,20m	15.0	<b>588620000</b>
	Follow the directions in the "Operating Instructions"!	<b>CE</b>

<b>Lifting beam 110kN 6.00m</b> Umsetzbalken 110kN 6,00m	136.5	<b>586359000</b>
	Galvanised	Length: 626 cm
	Follow the directions in the "Operating Instructions"!	<b>CE</b>

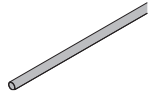

<b>Scaffold tube 48.3mm 0.50m</b>	1.7	<b>682026000</b>
<b>Scaffold tube 48.3mm 1.00m</b>	3.6	<b>682014000</b>
<b>Scaffold tube 48.3mm 1.50m</b>	5.4	<b>682015000</b>
<b>Scaffold tube 48.3mm 2.00m</b>	7.2	<b>682016000</b>
<b>Scaffold tube 48.3mm 2.50m</b>	9.0	<b>682017000</b>
<b>Scaffold tube 48.3mm 3.00m</b>	10.8	<b>682018000</b>
<b>Scaffold tube 48.3mm 3.50m</b>	12.6	<b>682019000</b>
<b>Scaffold tube 48.3mm 4.00m</b>	14.4	<b>682021000</b>
<b>Scaffold tube 48.3mm 4.50m</b>	16.2	<b>682022000</b>
<b>Scaffold tube 48.3mm 5.00m</b>	18.0	<b>682023000</b>
<b>Scaffold tube 48.3mm 5.50m</b>	19.8	<b>682024000</b>
<b>Scaffold tube 48.3mm 6.00m</b>	21.6	<b>682025000</b>
<b>Scaffold tube 48.3mm .....m</b>	3.6	<b>682001000</b>
Gerüstrohr 48,3mm		

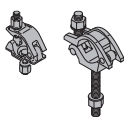
	Galvanised	
---	------------	--

	[kg]	Article n°
<b>Screw-on coupler 48mm 50</b>	0.84	<b>682002000</b>
<b>Screw-on coupler 48mm 95</b>	0.88	<b>586013000</b>
Anschraubkupplung		
		
Galvanised		
Width-across: 22 mm		
Follow fitting instructions!		

<b>Swivel coupler 48mm</b>	1.5	<b>582560000</b>
Drehkupplung 48mm		
		
Galvanised		
Width-across: 22 mm		
Follow fitting instructions!		

<b>Warning sign "No entry" 300x300mm</b>	0.70	<b>581575000</b>
Verbotsschild "Zutritt Verboten" 300x300mm		
		

<b>Doka personal fall-arrest set</b>	3.6	<b>583022000</b>
Doka-Auffanggurt		
		
Follow the directions in the "Operating Instructions"!		
		

<b>Tool box GF</b>	6.5	<b>580390000</b>
GF-Werkzeugbox		
included in scope of supply:		
(A) <b>Reversible ratchet 1/2"</b>	0.73	<b>580580000</b>
Galvanised		
Length: 30 cm		
(B) <b>Fork wrench 13/17</b>	0.08	<b>580577000</b>
(C) <b>Fork wrench 22/24</b>	0.22	<b>580587000</b>
(D) <b>Fork wrench 30/32</b>	0.80	<b>580897000</b>
(E) <b>Ring spanner 17/19</b>	0.27	<b>580590000</b>
(F) <b>Extension 11cm 1/2"</b>	0.20	<b>580581000</b>
(G) <b>Extension 22cm 1/2"</b>	0.31	<b>580582000</b>
(H) <b>Universal joint coupling 1/2"</b>	0.16	<b>580583000</b>
(I) <b>Box nut 19 1/2" L</b>	0.16	<b>580598000</b>
(J) <b>Box nut 13 1/2"</b>	0.06	<b>580576000</b>
(K) <b>Box nut 24 1/2"</b>	0.12	<b>580584000</b>
(L) <b>Box nut 30 1/2"</b>	0.20	<b>580575000</b>

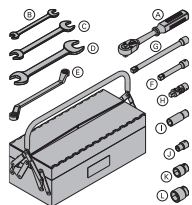

	[kg]	Article n°
<b>Additional tools MF</b>	4.1	<b>580682000</b>
Zusatzwerkzeuge MF		
consisting of:		
(A) <b>Reversible ratchet 3/4"</b>	1.5	<b>580894000</b>
Galvanised		
Length: 50 cm		
(B) <b>Box nut 17 1/2"</b>	0.07	<b>580685000</b>
(C) <b>Box nut 50 3/4"</b>	0.81	<b>581449000</b>
(D) <b>Extension 20cm 3/4"</b>	0.68	<b>580683000</b>
(E) <b>Transition piece A 1/2"x3/4"</b>	0.18	<b>580684000</b>
(F) <b>Universal cone spanner 15.0/20.0</b>	0.90	<b>581448000</b>
Galvanised		
Length: 9 cm		
Width-across: 50 mm		

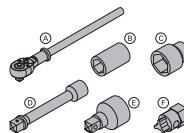

<b>Mounting tool for form-ply protector</b>	0.96	<b>580222000</b>
Montagewerkzeug Schalhautschutz		
Galvanised		
Width: 12 cm		
Height: 12 cm		

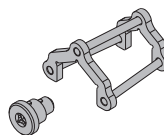

<b>Box nut 24 1/2" L</b>	0.30	<b>586364000</b>
Stecknuss 24 1/2" L		



<b>Combination wrench 24</b>	0.25	<b>582839000</b>
Ring-Maulschlüssel 24		



<b>Ratchet MF 3/4" SW50</b>	3.8	<b>580648000</b>
Antriebsknarre MF 3/4" SW50		
Galvanised		

