

	[kg]	Art.-Nr.
Abstützbock Variabel 3,30m Supporting construct. frame "Variable" 3.30m bestehend aus:	187,8	580516000
(A) Abstützbockriegel WU14 blau lackiert Höhe: 252 cm	99,0	580510000
(B) Mehrweckriegel WS10 Top50 2,00m blau lackiert	38,9	580007000
(C) Zuglasche blau lackiert Länge: 19 cm	2,5	580534000
(D) Stütزشuh blau lackiert Länge: 28 cm	9,5	580532000
(E) Verbindungsbolzen 10cm verzinkt Länge: 14 cm	0,34	580201000
(F) Federvorstecker 5mm verzinkt Länge: 13 cm	0,05	580204000
(G) Spindelstrebe 12 3,00m blau lackiert Länge: 201 - 234 cm	32,0	580521000
(H) Anschraubkupplung 48mm 50 verzinkt Schlüsselweite: 22 mm Einbauanleitung beachten!	0,84	682002000

blau lackiert

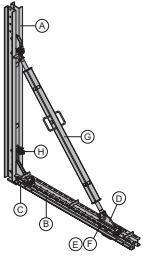

Abstützbockriegel WU14 Waling WU14 for supporting construction frame bestehend aus:	99,0	580510000
(A) Abstützbockprofil WU14 blau lackiert Höhe: 250 cm	81,0	580509000
(B) Druckschuh blau lackiert Höhe: 32 cm	6,2	580531000
(C) Verankerungsschuh blau lackiert Höhe: 51 cm	12,0	580533000

blau lackiert
Höhe: 252 cm

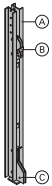

Stütزشuh Supporting shoe	9,5	580532000
------------------------------------	-----	------------------

blau lackiert
Länge: 28 cm



Zuglasche Tension plate	2,5	580534000
-----------------------------------	-----	------------------

blau lackiert
Länge: 19 cm



Mehrweckriegel WS10 Top50 1,00m	19,6	580003000
Mehrweckriegel WS10 Top50 1,75m	35,0	580006000
Mehrweckriegel WS10 Top50 2,00m	38,9	580007000
Mehrweckriegel WS10 Top50 2,50m	48,7	580009000
Mehrweckriegel WS10 Top50 2,75m	54,2	580010000
Mehrweckriegel WS10 Top50 3,00m	58,9	580011000
Mehrweckriegel WS10 Top50 3,50m	68,4	580012000
Mehrweckriegel WS10 Top50 4,00m	79,4	580013000

Multi-purpose waling WS10 Top50

blau lackiert

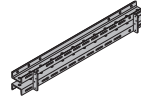

Spindelstrebe 12 3,00m Spindle strut 12 3.00m	32,0	580521000
---	------	------------------

blau lackiert
Länge: 201 - 234 cm



Spindelstrebe T7 305/355cm Spindle strut T7 305/355cm	35,0	584327000
---	------	------------------

verzinkt

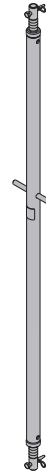

Elementverbinder FF20/50 Z Formwork element connector FF20/50 Z	6,0	587533000
---	-----	------------------

blau lackiert
Länge: 55 cm

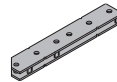

Verbindungsbolzen 10cm Connecting pin 10cm	0,34	580201000
--	------	------------------

verzinkt
Länge: 14 cm



Federvorstecker 5mm Spring cotter 5mm	0,05	580204000
---	------	------------------

verzinkt
Länge: 13 cm



Bockdistanz 20cm Supporting construction distancer 20cm	9,4	580519000
---	-----	------------------

verzinkt
Länge: 25 cm
Breite: 19 cm
Höhe: 20 cm



	[kg]	Art.-Nr.
Riegelhalter 9-15cm Waling-to-bracket holder 9-15cm	2,7	580625000



verzinkt

Keilriegelhalter Waling-to-bracket holder	2,5	580526000
---	-----	------------------



verzinkt
Länge: 26 cm
Höhe: 31 cm

Framax-Universalverbinder 10-16cm Framax universal fixing bolt 10-16cm	0,60	588158000
--	------	------------------



verzinkt
Länge: 26 cm

Framax-Universalverbinder 10-25cm Framax universal fixing bolt 10-25cm	0,69	583002000
--	------	------------------



verzinkt
Länge: 36 cm

Framax-Spannklemme Framax wedge clamp	1,5	588152000
---	-----	------------------



verzinkt
Länge: 21 cm

Anschraubkupplung 48mm 50	0,84	682002000
Anschraubkupplung 48mm 95	0,88	586013000

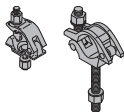

verzinkt
Schlüsselweite: 22 mm
Einbauanleitung beachten!

Drehkupplung 48mm Swivel coupler 48mm	1,5	582560000
---	-----	------------------



verzinkt
Schlüsselweite: 22 mm
Einbauanleitung beachten!

Gerüstrohr 48,3mm 0,50m	1,7	682026000
Gerüstrohr 48,3mm 1,00m	3,6	682014000
Gerüstrohr 48,3mm 1,50m	5,4	682015000
Gerüstrohr 48,3mm 2,00m	7,2	682016000
Gerüstrohr 48,3mm 2,50m	9,0	682017000
Gerüstrohr 48,3mm 3,00m	10,8	682018000
Gerüstrohr 48,3mm 3,50m	12,6	682019000
Gerüstrohr 48,3mm 4,00m	14,4	682021000
Gerüstrohr 48,3mm 4,50m	16,2	682022000
Gerüstrohr 48,3mm 5,00m	18,0	682023000
Gerüstrohr 48,3mm 5,50m	19,8	682024000
Gerüstrohr 48,3mm 6,00m	21,6	682025000
Gerüstrohr 48,3mmm	3,6	682001000

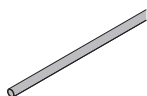

verzinkt

Anschraubbühne MF75 Screw-on access bracket MF75	19,0	580669000
--	------	------------------



verzinkt
Länge: 113 cm
Höhe: 152 cm

	[kg]	Art.-Nr.
Schwenkplatte MF Swivel plate MF	4,5	580672000



verzinkt
Länge: 29 cm
Höhe: 20 cm

Prüfbock für Schräganker 15,0/20,0 Testing truss for diagonal anchors 15.0/20.0	13,5	580514000
---	------	------------------

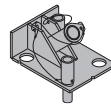

verzinkt
Länge: 32 cm
Breite: 25 cm
Höhe: 19 cm

Universal-Werkzeugbox 15,0 Universal tool box 15.0	9,1	580392000
--	-----	------------------

Im Lieferumfang enthalten:

(A) Umschaltknarre 1/2" verzinkt Länge: 30 cm	0,73	580580000
(B) Gabelschlüssel 13/17	0,08	580577000
(C) Gabelschlüssel 22/24	0,22	580587000
(D) Gabelschlüssel 30/32	0,80	580897000
(E) Gabelschlüssel 36/41	1,0	580586000
(F) Ringschlüssel 17/19	0,27	580590000
(G) Vierkantnuss 22	0,31	580589000
(H) Steckschlüssel 41	0,99	580585000
(I) Verlängerung 11cm 1/2"	0,20	580581000
(J) Verlängerung 22cm 1/2"	0,31	580582000
(K) Kardangelenk 1/2"	0,16	580583000
(L) Stecknuss 19 1/2" L	0,16	580598000
(M) Stecknuss 13 1/2"	0,06	580576000
(N) Stecknuss 24 1/2"	0,12	580584000
(O) Stecknuss 30 1/2"	0,20	580575000
(P) Vorlaufschlüssel 15,0 DK verzinkt Länge: 8 cm Schlüsselweite: 30 mm	0,30	580579000

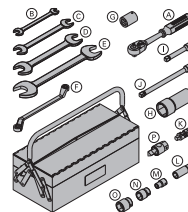

	[kg]	Art.-Nr.
Abstützbock-Universal F 4,50m Supporting construct. frame Universal F 4.50m	306,0	580500000
blau lackiert Länge: 196 cm Höhe: 365 - 394 cm		

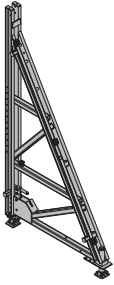

Anbaurahmen F 1,50m Attachable frame F 1.50m	236,0	580502000
blau lackiert Länge: 280 cm		

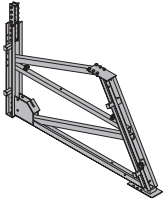

Anbaurahmen F 2,00m Attachable frame F 2.00m	451,0	580501000
blau lackiert Länge: 394 cm		

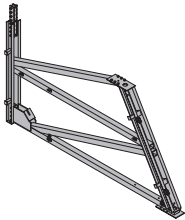

Abstützbockspindel vorne Front spindle for supp. construction frame	17,0	580508000
verzinkt		

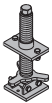

Abstützbockspindel hinten Rear spindle for supp. construction frame	18,3	580515000
verzinkt		

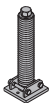

Ankerriegel 0,70m	27,0	580517000
Ankerriegel 1,95m	76,3	580545000
Ankerriegel 2,95m	110,0	580546000
Anchor waling		
blau lackiert		



Mehrweckriegel WS10 Top50 1,00m	19,6	580003000
Mehrweckriegel WS10 Top50 1,75m	35,0	580006000
Mehrweckriegel WS10 Top50 2,00m	38,9	580007000
Mehrweckriegel WS10 Top50 2,50m	48,7	580009000
Mehrweckriegel WS10 Top50 2,75m	54,2	580010000
Mehrweckriegel WS10 Top50 3,00m	58,9	580011000
Mehrweckriegel WS10 Top50 3,50m	68,4	580012000
Mehrweckriegel WS10 Top50 4,00m	79,4	580013000
Multi-purpose waling WS10 Top50		
blau lackiert		

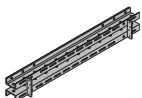

	[kg]	Art.-Nr.
Mehrweckriegel WU12 Top50 2,00m	50,0	580022000
Mehrweckriegel WU12 Top50 3,00m	75,7	580024000
Multi-purpose waling WU12 Top50		
blau lackiert		

Ankerprofil 0,55m Anchoring profile 0.55m	44,5	582904000
blau lackiert		

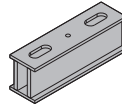

Ankerriegelhalter Anchor waling positioner	0,62	580539000
verzinkt Länge: 31 cm		

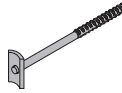

Ecklasche Abstützbock Corner plate supporting constr. frame	44,4	580518000
blau lackiert Länge: 92 cm Breite: 92 cm		

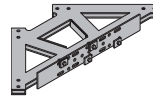

Fassadenriegel WS10 2,50m Facade waling WS10 2.50m	50,0	580692000
blau lackiert		

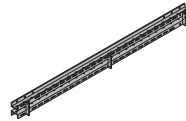

Bockdistanz 20cm Supporting construction distancer 20cm	9,4	580519000
verzinkt Länge: 25 cm Breite: 19 cm Höhe: 20 cm		



Klemme für Bockdistanz 20cm Clamp for supp. constr. distancer 20cm	5,0	582920000
verzinkt Länge: 36 cm Breite: 7 cm		



Riegelhalter 9-15cm Waling-to-bracket holder 9-15cm	2,7	580625000
verzinkt		



Keilriegelhalter Waling-to-bracket holder	2,5	580526000
verzinkt Länge: 26 cm Höhe: 31 cm		



Framax-Universalverbinder 10-16cm Framax universal fixing bolt 10-16cm	0,60	588158000
verzinkt Länge: 26 cm		



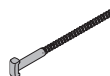

Framax-Universalverbinder 10-25cm Framax universal fixing bolt 10-25cm	0,69	583002000
verzinkt Länge: 36 cm		



	[kg]	Art.-Nr.
Framax-Spannklemme Framax wedge clamp	1,5	588152000
 verzinkt Länge: 21 cm		

Framax-Bocklasche Framax supporting construct. frame connector	15,0	580506000
 blau lackiert Höhe: 77 cm		

Framax-Bockschraube 36cm Framax supporting construct. frame bolt 36cm	0,62	580505000
 verzinkt		

Ansteckrolle 200 Attachable roller 200	19,3	580538000
 blau lackiert Höhe: 38 cm		

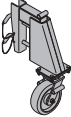
Ansteckrolle 250 Attachable roller 250	47,0	580537000
 blau lackiert Höhe: 78 cm		

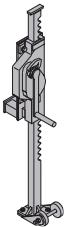
Hubwinde mit Transportroller Winch with transport device	37,0	580541000
 blau lackiert Höhe: 127 cm Betriebsanleitung beachten!		CE

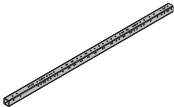
Verfahrprofil F 2,00m vorne Travelling profile F 2.00m front	180,0	582925000
 verzinkt Länge: 600 cm		

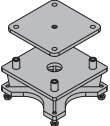
Radanschluss F 2,00m vorne Wheel connector F 2.00m front	33,7	582926000
 verzinkt Länge: 30 cm Breite: 30 cm Höhe: 16,5 cm		

Klemmbacke F 2,00m Clamping jaw F 2.00m	0,82	582927000
 verzinkt Länge: 12,5 cm		

Klemmplatte F 2,00m Clamping plate F 2.00m	3,5	582928000
 verzinkt Länge: 24 cm		

	[kg]	Art.-Nr.
Zwischenplatte F 2,00m Intermediate plate F 2.00m	6,0	582929000
 verzinkt Länge: 25 cm Breite: 18 cm		

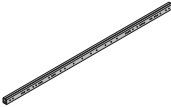
Verfahrprofil F 2,00m hinten Travelling profile F 2.00m rear	187,5	582930000
 verzinkt Länge: 574 cm		

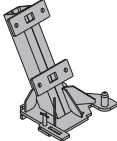
Radanschluss F 2,00m hinten Wheel connector F 2.00m rear	44,5	582931000
 verzinkt Höhe: 61,5 cm		

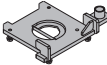
Anschlussplatte F 2,00m Connection plate F 2.00m	15,8	582932000
 verzinkt Länge: 44,1 cm Breite: 35,7 cm		

Schraubplatte F 2,00m Bolting plate F 2.00m	2,9	582933000
 verzinkt Länge: 20 cm		

Verbindungsplatte F 2,00m Connector plate F 2.00m	2,3	582934000
 verzinkt Länge: 42 cm		

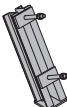
Hubkonsole F 2,00m hinten Lifting bracket F 2.00m rear	14,0	582935000
 verzinkt Höhe: 48,6 cm		

Aufhängeschuh Abstützbock horizontal Suspension shoe for horiz. supp.constr. frame	11,0	580530000
 blau lackiert Länge: 45 cm		

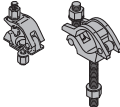
Anschraubkupplung 48mm 50 Anschraubkupplung 48mm 95 Screw-on coupler	0,84 0,88	682002000 586013000
 verzinkt Schlüsselweite: 22 mm Einbauanleitung beachten!		

Drehkupplung 48mm Swivel coupler 48mm	1,5	582560000
 verzinkt Schlüsselweite: 22 mm Einbauanleitung beachten!		

	[kg]	Art.-Nr.
Gerüstrohr 48,3mm 0,50m	1,7	682026000
Gerüstrohr 48,3mm 1,00m	3,6	682014000
Gerüstrohr 48,3mm 1,50m	5,4	682015000
Gerüstrohr 48,3mm 2,00m	7,2	682016000
Gerüstrohr 48,3mm 2,50m	9,0	682017000
Gerüstrohr 48,3mm 3,00m	10,8	682018000
Gerüstrohr 48,3mm 3,50m	12,6	682019000
Gerüstrohr 48,3mm 4,00m	14,4	682021000
Gerüstrohr 48,3mm 4,50m	16,2	682022000
Gerüstrohr 48,3mm 5,00m	18,0	682023000
Gerüstrohr 48,3mm 5,50m	19,8	682024000
Gerüstrohr 48,3mm 6,00m	21,6	682025000
Gerüstrohr 48,3mmm	3,6	682001000
Scaffold tube 48.3mm		

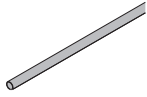

verzinkt

Anschraubühne MF75 Screw-on access bracket MF75	19,0	580669000
---	------	-----------



verzinkt
Länge: 113 cm
Höhe: 152 cm

Schwenkplatte MF Swivel plate MF	4,5	580672000
--	-----	-----------



verzinkt
Länge: 29 cm
Höhe: 20 cm

Schutzgeländerzwing S Handrail clamp S	11,5	580470000
--	------	-----------



verzinkt
Höhe: 123 - 171 cm

Prüfbock für Schräganker 15,0/20,0 Testing truss for diagonal anchors 15.0/20.0	13,5	580514000
---	------	-----------

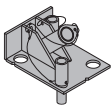

verzinkt
Länge: 32 cm
Breite: 25 cm
Höhe: 19 cm

Universal-Werkzeugbox 15,0 Universal tool box 15.0	9,1	580392000
Im Lieferumfang enthalten: (A) Umschaltknarre 1/2" verzinkt Länge: 30 cm	0,73	580580000
(B) Gabelschlüssel 13/17	0,08	580577000
(C) Gabelschlüssel 22/24	0,22	580587000
(D) Gabelschlüssel 30/32	0,80	580897000
(E) Gabelschlüssel 36/41	1,0	580586000
(F) Ringschlüssel 17/19	0,27	580590000
(G) Vierkantnuss 22	0,31	580589000
(H) Steckschlüssel 41	0,99	580585000
(I) Verlängerung 11cm 1/2"	0,20	580581000
(J) Verlängerung 22cm 1/2"	0,31	580582000
(K) Kardangelenke 1/2"	0,16	580583000
(L) Stecknuss 19 1/2" L	0,16	580598000
(M) Stecknuss 13 1/2"	0,06	580576000
(N) Stecknuss 24 1/2"	0,12	580584000
(O) Stecknuss 30 1/2"	0,20	580575000
(P) Vorlaufschlüssel 15,0 DK verzinkt Länge: 8 cm Schlüsselweite: 30 mm	0,30	580579000

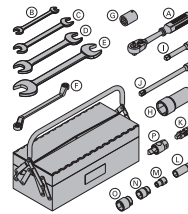

Umschaltknarre 3/4" Reversible ratchet 3/4"	1,5	580894000
---	-----	-----------

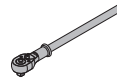

verzinkt
Länge: 50 cm

Stecknuss 46 3/4" Box nut 46 3/4"	0,70	580512000
---	------	-----------



Verlängerung 20cm 3/4" Extension 20cm 3/4"	0,68	580683000
--	------	-----------



Konusschlüssel 20,0 Cone spanner 20.0	3,5	581471000
---	-----	-----------

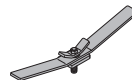

verzinkt
Länge: 57 cm

Lösewerkzeug Freistellkonus Clearance-cone dismantling tool	0,67	581864000
---	------	-----------



verzinkt
Länge: 10,7 cm
Schlüsselweite: 24 mm

Spindelstrebe T6 100/150cm Spindle strut T6 100/150cm	12,5	584323000
---	------	-----------



verzinkt

	[kg]	Art.-Nr.
Spindelstrebe T7 100/150cm Spindle strut T7 100/150cm	16,8	584309000
verzinkt		
		

Spindelstrebe T7 200/250cm Spindle strut T7 200/250cm	26,2	584325000
verzinkt		
		

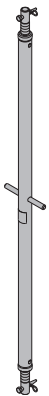
Spindelstrebe T7 250/300cm Spindle strut T7 250/300cm	29,4	584326000
verzinkt		
		

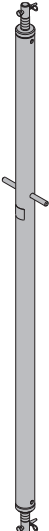
Spindelstrebe T10 350/400cm Spindle strut T10 350/400cm	57,5	584328000
verzinkt		
		

	[kg]	Art.-Nr.
Spindelstrebe SL-1 T16 100/140cm Spindle strut SL-1 T16 100/140cm	54,1	582871000
verzinkt		
		

Spindelstrebe SL-1 T16 140/225cm Spindle strut SL-1 T16 140/225cm	87,8	582872000
verzinkt		
		

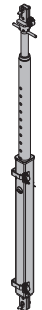
Spindelstrebe SL-1 T16 220/375cm Spindle strut SL-1 T16 220/375cm	123,0	582874000
verzinkt		
		

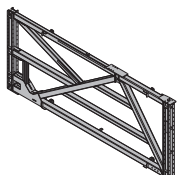
Anbaurahmen F 2,40m Attachable frame F 2.40m	1107,0	582901000
blau lackiert Länge: 576 cm		
		

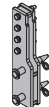
Aufstocklasche F 2,40m Stacking plate F 2.40m	32,5	582902000
blau lackiert Höhe: 63,5 cm		
		

Spindel für Anbaurahmen F 2,40m Spindle for attachable frame F 2.40m	20,1	582903000
verzinkt Höhe: 47,5 cm		
		

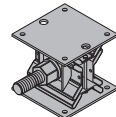
Absenkeil 1000kN Lowering wedge 1000kN	53,5	582905000
blau lackiert Höhe: 19,2 - 27,2 cm		
		

Ringschlüssel 80 Ring spanner 80	3,8	582906000
verzinkt Länge: 62,4 cm		
		

	[kg]	Art.-Nr.
Verschwertungsprofil 2,95m Bracing profile 2.95m	42,5	582907000
 blau lackiert		

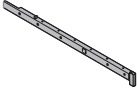
Bühnenprofil 1,00m für Abstützbock Platform profile 1.00m f. supp. constr. frame	10,7	582908000
 verzinkt Länge: 147,5 cm		

Auszugsicherung für Bühnenprofil Extension safety clamp for platform profile	1,7	582909000
 verzinkt Länge: 38,4 cm		

Geländer 1,00m Handrail post 1.00m	3,8	584335000
 verzinkt Länge: 124 cm		

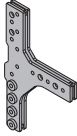
T-Lasche für Abstützbock T plate for supporting construction frame	29,8	582910000
 blau lackiert Länge: 74,6 cm		

Verbindungsbolzen SL-1 D32 100 Connecting pin SL-1 D32 100	1,0	582885000
 verzinkt Länge: 17 cm		

Einschubgeländer T 1,80m Handrail post T 1.80m	17,7	584373000
 verzinkt		

Fußwehrhalter T 1,80m Toeboard holder T 1.80m	0,53	584392000
 verzinkt Höhe: 13,5 cm		

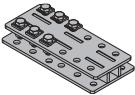
Zwischenflansch für Abstützbock Intermediate flange for supp. constr. frame	16,2	582911000
 blau lackiert Länge: 42,7 cm		

Stütزشuh WU16 Supporting shoe WU16	8,3	582912000
 blau lackiert Länge: 26,5 cm		

	[kg]	Art.-Nr.
Druckschuh T7/T16 Pressure shoe T7/T16	18,5	582913000
 blau lackiert Höhe: 72,5 cm		

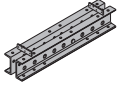
Mehrzweckriegel SL-1 WU16 1,00m	35,0	582877000
Mehrzweckriegel SL-1 WU16 3,00m	107,0	582888000
Multi-purpose waling SL-1		
 blau lackiert		

Riegelverbinder SL-1 WU16 0,75m Waling connector SL-1 WU16 0.75m	31,0	582886000
 verzinkt Länge: 75 cm		

Schwerlastrad 90kN Heavy-duty wheel 90kN	85,0	582921000
 verzinkt Höhe: 38 cm		

Radanschluss F 2,40m Wheel connector F 2.40m	45,0	582922000
 verzinkt Länge: 49 cm Breite: 36 cm Höhe: 25 cm		

Verfahrprofil-Konsole F 2,40m Travelling profile bracket F 2.40m	31,0	582924000
 verzinkt Länge: 28,5 cm Breite: 22 cm Höhe: 48,2 cm		