

[kg] Art.-Nr.

Ankersystem 15,0

| | | |
|-------------------------------------|------|-----------|
| Ankerstab 15,0mm verzinkt 0,50m | 0,72 | 581821000 |
| Ankerstab 15,0mm verzinkt 0,75m | 1,1 | 581822000 |
| Ankerstab 15,0mm verzinkt 1,00m | 1,4 | 581823000 |
| Ankerstab 15,0mm verzinkt 1,25m | 1,8 | 581826000 |
| Ankerstab 15,0mm verzinkt 1,50m | 2,2 | 581827000 |
| Ankerstab 15,0mm verzinkt 1,75m | 2,5 | 581828000 |
| Ankerstab 15,0mm verzinkt 2,00m | 2,9 | 581829000 |
| Ankerstab 15,0mm verzinkt 2,50m | 3,6 | 581852000 |
| Ankerstab 15,0mm verzinktm | 1,4 | 581824000 |
| Ankerstab 15,0mm unbehandelt 0,50m | 0,73 | 581870000 |
| Ankerstab 15,0mm unbehandelt 0,75m | 1,1 | 581871000 |
| Ankerstab 15,0mm unbehandelt 1,00m | 1,4 | 581874000 |
| Ankerstab 15,0mm unbehandelt 1,25m | 1,8 | 581886000 |
| Ankerstab 15,0mm unbehandelt 1,50m | 2,1 | 581876000 |
| Ankerstab 15,0mm unbehandelt 1,75m | 2,5 | 581887000 |
| Ankerstab 15,0mm unbehandelt 2,00m | 2,9 | 581875000 |
| Ankerstab 15,0mm unbehandelt 2,50m | 3,6 | 581877000 |
| Ankerstab 15,0mm unbehandelt 3,00m | 4,3 | 581878000 |
| Ankerstab 15,0mm unbehandelt 3,50m | 5,0 | 581888000 |
| Ankerstab 15,0mm unbehandelt 4,00m | 5,7 | 581879000 |
| Ankerstab 15,0mm unbehandelt 5,00m | 7,2 | 581880000 |
| Ankerstab 15,0mm unbehandelt 6,00m | 8,6 | 581881000 |
| Ankerstab 15,0mm unbehandelt 7,50m | 10,7 | 581882000 |
| Ankerstab 15,0mm unbehandeltm | 1,4 | 581873000 |

Tie rod 15.0mm

Flügelmutter 15,0

Wing nut 15.0

0,31 581961000



verzinkt
Länge: 10 cm
Höhe: 5 cm
Schlüsselweite: 27 mm

Superplatte 15,0

Super plate 15.0

1,1 581966000



verzinkt
Höhe: 6 cm
Durchmesser: 12 cm
Schlüsselweite: 27 mm

Sechskantmutter 15,0

Hexagon nut 15.0

0,23 581964000



verzinkt
Länge: 5 cm
Schlüsselweite: 30 mm

Ankerplatte 12/12

Anchor plate 12/12

1,3 581930000



verzinkt

Ankerplatte 15/20

Anchor plate 15/20

1,8 581929000



verzinkt

Winkelplatte 12/18

Angle anchor plate 12/18

1,5 581934000

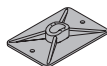

verzinkt

Frami-Druckplatte 8/9

Frami pressure plate 8/9

0,55 588466000



verzinkt

Top50-Ankermutter 15,0

Top50 form-tie nut 15.0

[kg] Art.-Nr.

3,8 580073000

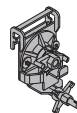

verzinkt
Höhe: 25 cm

Nagelblech 15,0

Fixing plate 15.0

0,15 581692000



verzinkt
Durchmesser: 10 cm

Vorlaufkonus 15,0 5cm

Positioning cone 15.0 5cm

0,43 581969000

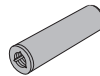

verzinkt
Länge: 11 cm
Durchmesser: 3 cm
Werkzeug: Vorlaufschlüssel
15,0 DK
Einbauanleitung beachten!

Kletterkonus 15,0 5cm

Climbing cone 15.0 5cm

0,97 581980000

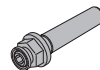

verzinkt
Länge: 17 cm
Durchmesser: 6 cm
Schlüsselweite: 41 mm
Einbauanleitung beachten!

Dichtungshülse 15,0 5cm

Sealing sleeve 15.0 5cm

0,008 581990000



orange
Länge: 10 cm
Durchmesser: 3 cm

Ankerkopf 15,0 5cm

She-bolt 15.0 5cm

1,7 581972000



verzinkt
Länge: 76 cm
Schlüsselweite: 24 mm
Einbauanleitung beachten!

Ankerkopf 15,0 5cm 1,20m

She-bolt 15.0 5cm 1.20m

2,5 581832000



verzinkt
Länge: 131 cm
Schlüsselweite: 24 mm
Einbauanleitung beachten!

Sperrenvorlauf 15,0 5cm

Cantilever positioning cone 15.0 5cm

0,45 581699000



Länge: 11 cm
Durchmesser: 5 cm
Werkzeug: Vorlaufschlüssel
15,0 DK
Einbauanleitung beachten!

Dichtungshülse S 15,0 5cm

Sealing sleeve S 15.0 5cm

0,009 581697000



orange
Länge: 11 cm
Durchmesser: 4,7 cm







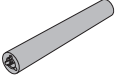
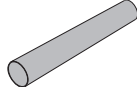

Sichtbetonvorlauf 15,0 5cm

Fair-faced concrete positioning cone 15.0 5cm

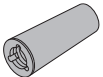

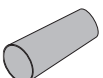









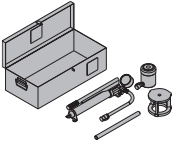

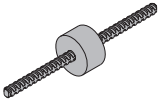
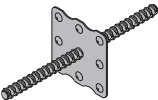





0,46 581973000





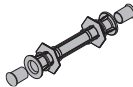







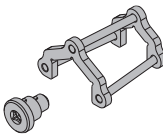
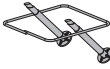

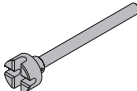

verzinkt
Länge: 11 cm
Durchmesser: 4,3 cm
Werkzeug: Vorlaufschlüssel
15,0 DK

| | [kg] | Art.-Nr. |
|--|------|------------------|
| Aufhängekonus 15,0 5cm Suspension cone 15.0 5cm | 0,88 | 581971000 |
|  verzinkt Länge: 16 cm Durchmesser: 6 cm Einbauanleitung beachten! | | |
| Aufhängekonus 15,0 für Isolierung bis 11cm Suspension cone 15.0 f. insulation up to 11cm | 3,6 | 580495000 |
|  verzinkt Länge: 30 cm Durchmesser: 5 cm | | |
| Dichtungshülse 15,0 für Isolierung bis 11cm Sealing sleeve 15.0 f. insulation up to 11cm | 0,05 | 580498000 |
|  naturweiß Länge: 30 cm Durchmesser: 6 cm | | |
| Konusschraube Rd28 Cone screw Rd28 | 0,65 | 580496000 |
|  verzinkt Länge: 9 cm Durchmesser: 6 cm | | |
| Vorlaufscheibe Rd28 Positioning disk Rd28 | 0,25 | 580497000 |
|  verzinkt Durchmesser: 9 cm | | |
| Universal-Kletterkonus 15,0 Universal climbing cone 15.0 | 1,3 | 581977000 |
|  verzinkt Länge: 13 cm Durchmesser: 5 cm Werkzeug: Universal-Konusschlüssel 15,0/20,0 | | |
| Konusschraube B 7cm Cone screw B 7cm | 0,86 | 581444000 |
|  rot Länge: 10 cm Durchmesser: 7 cm Schlüsselweite: 50 mm | | |
| Dichtungshülse K 15,0 Sealing sleeve K 15.0 | 0,03 | 581976000 |
|  orange Länge: 12 cm Durchmesser: 6 cm | | |
| Sichtbetonvorlauf MF 15,0 Fair-faced concrete positioning cone MF 15.0 | 1,5 | 581928000 |
|  verzinkt Länge: 12,6 cm Durchmesser: 5,3 cm Werkzeug: Universal-Konusschlüssel 15,0/20,0 | | |
| Vorlaufscheibe M30 Positioning disk M30 | 0,25 | 581975000 |
|  verzinkt Durchmesser: 9 cm | | |
| Vorlaufklemme M30 Positioning clamp M30 | 0,19 | 581833000 |
|  verzinkt Durchmesser: 4 cm | | |

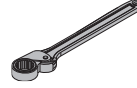
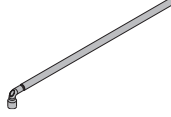
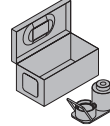
| | [kg] | Art.-Nr. |
|--|--------------|--------------------------------------|
| Einschraubkonus 15,0 Screw-in cone 15.0 | 0,74 | 581895000 |
|  verzinkt Länge: 15 cm | | |
| Gesimsanker 15,0 Gesimsanker 15,0 verzinkt Bridge edge beam anchor 15.0 | 0,45 0,44 | 581896000 581890000 |
|  Länge: 7 cm Einbauanleitung beachten! | | |
| Nagelkonus 15,0 Nailing cone 15.0 | 0,02 | 581897000 |
|  schwarz Länge: 7 cm | | |
| Gesimsankerstopfen 29mm Hole plug 29mm | 0,003 | 581891000 |
|  grau Durchmesser: 3 cm | | |
| Zinkstöpsel 15,0 Zinc plug 15.0 | 0,20 | 581889000 |
|  verzinkt Länge: 9,9 cm Durchmesser: 2,9 cm Werkzeug: Außenvierkantschlüssel 1/2" | | |
| Sperranker 15,0 11,5cm 90 Stop anchor 15.0 11.5cm 90 | 0,55 | 581868000 |
|  unbehandelt | | |
| Sperranker 15,0 16cm 55 Stop anchor 15.0 16cm 55 | 0,38 | 581997000 |
|  unbehandelt | | |
| Sperranker 15,0 40cm 55 Stop anchor 15.0 40cm 55 | 0,71 | 581999000 |
|  unbehandelt | | |
| Sperranker beidseitig 15,0 20cm 90 Stop anchor double-ended 15.0 20cm 90 | 0,76 | 581820000 |
|  unbehandelt Sonderlängen können unter der Sonder-Art.-Nr. 580100000 unter Angabe der Bezeichnung und der gewünschten Länge in mm bestellt werden. | | |
| Wellenanker 15,0 Pigtail anchor 15.0 | 0,92 | 581984000 |
|  unbehandelt Länge: 67 cm | | |
| Wandanker 15,0 15cm Wall anchor 15.0 15cm | 1,5 | 581893000 |
|  verzinkt | | |

| | [kg] | Art.-Nr. | | [kg] | Art.-Nr. |
|--|-------------------------------------|---|---|--|---|
| Bund-Aufhängekonus 15,0 Suspension cone 15.0 with collar | 1,4 | 580428000 |  | unbehandelt Länge: 16 cm Durchmesser: 6 cm Einbauanleitung beachten! | |
| Felsanker-Spreizeinheit 15,0 Rock anchor spreader unit 15.0 | 0,41 | 581120000 |  | verzinkt Länge: 9 cm Durchmesser: 4 cm Einbauanleitung beachten! | |
| Felsanker-Einbaurohr Rock anchor installation tube | 0,85 | 581123000 |  | verzinkt Länge: 50 cm Durchmesser: 3 cm | |
| Vorspanngerät 300kN Tensioning instrument 300kN | 32,0 | 581815000 |  | verzinkt | |
| Wasserstopp 15,0 Water stop connector 15.0 | 0,52 | 581914000 |  | unbehandelt Länge: 12 cm | |
| Wassersperre 15,0 33cm Wassersperre S 15,0 33cm Water stop with tie rod 15.0 | 1,3 1,2 | 581817000 581819000 |  | unbehandelt Länge: 33 cm Durchmesser: 7 cm Sonderlängen können unter der Sonder-Art.-Nr. 580100000 unter Angabe der Bezeichnung und der gewünschten Länge in mm bestellt werden. | |
| Wassersperre G 15,0 33cm Water stop G 15.0 33cm | 0,68 | 581818000 |  | unbehandelt Länge: 33 cm Breite: 12 cm Höhe: 12 cm Sonderlängen können unter der Sonder-Art.-Nr. 580100000 unter Angabe der Bezeichnung und der gewünschten Länge in mm bestellt werden. | |
| Faserbetonstopfen 30,7mm Faserbetonstopfen 32mm Faserbetonstopfen 45mm Faserbetonstopfen 54mm Fibre concrete plug | 0,03 0,02 0,10 0,16 | 581902000 581830000 581438000 581955000 |  | grau | |
| Betonkonus 52mm Concrete cone 52mm | 0,19 | 581939000 |  | grau | |
| Verbindungsuffe 15,0 Rod connector 15.0 | 0,49 | 581981000 |  | unbehandelt Länge: 11 cm Durchmesser: 3 cm |  |
| Anschweißuffe 15,0 Weldable coupler 15.0 | 0,25 | 581691000 |  | unbehandelt Länge: 8 cm Durchmesser: 3 cm Sicherheitshinweis: Darf nicht mit eingeschraubtem Ankerstab geschweißt werden - sonst Bruchgefahr! |  |
| Anschweißuffe 15,0 für Spundwand Weldable coupler 15.0 for sheet wall | 0,75 | 581693000 |  | unbehandelt Länge: 10 cm Höhe: 13 cm | |
| Spannkonus 15,0 Anchor cone 15.0 | 0,46 | 581967000 |  | gelb Länge: 11 cm Durchmesser: 6 cm |  |
| Kunststoffrohr 22mm 2,50m Plastic tube 22mm 2.50m | 0,45 | 581951000 |  | | |
| Universal-Konus 22mm Universal cone 22mm | 0,005 | 581995000 |  | grau Durchmesser: 4 cm | |
| Verschlussstopfen 22mm Plug 22mm | 0,003 | 581953000 |  | grau | |
| Distanzhalter 20cm Distanzhalter 25cm Distanzhalter 30cm Distancer | 0,04 0,05 0,06 | 581907000 581908000 581909000 |  | grau | |
| Faserbetonrohr 22mm 0,18m Faserbetonrohr 22mm 0,23m Faserbetonrohr 22mm 0,28m Faserbetonrohr 22mm 0,38m Faserbetonrohr 22mm 1,25m Fibre concrete tube 22mm | 0,28 0,36 0,44 0,61 2,3 | 581904000 581905000 581906000 581903000 581991000 |  | | |
| Faserbetonstopfen 22mm Fibre concrete plug 22mm | 0,02 | 581992000 |  | | |
| REPOXAL-Zweikomponenten Kleber REPOXAL two component adhesive | 1,2 | 581993000 | | | |
| Reduzierstück 26/22mm Reducer 26/22mm | 0,01 | 581853000 |  | schwarz | |

| | [kg] | Art.-Nr. |
|---|------|------------------|
| Schalhautschutz 22mm Form-ply protector 22mm | 0,25 | 580219000 |
|  verzinkt Schlüsselweite: 46 mm | | |
| Schalhautschutz 32mm Form-ply protector 32mm | 0,38 | 580220000 |
|  verzinkt Schlüsselweite: 70 mm | | |
| Montagewerkzeug Schalhautschutz Mounting tool for form-ply protector | 0,96 | 580222000 |
|  verzinkt Breite: 12 cm Höhe: 12 cm | | |
| Doppelanker 15,0 Double anchor 15.0 | 2,0 | 581431000 |
|  orange Breite: 35 cm | | |
| Ankerhalter 15,0 Anchor holder 15.0 | 0,43 | 581835000 |
|  unbehandelt | | |
| Freistellkonus 15,0 Clearance cone 15.0 | 0,51 | 581865000 |
|  schwarz blau Länge: 20,6 cm Durchmesser: 7 cm Einbauanleitung beachten! | | |
| Lösewerkzeug Freistellkonus Clearance-cone dismantling tool | 0,67 | 581864000 |
|  verzinkt Länge: 10,7 cm Schlüsselweite: 24 mm | | |
| Schutzkappe 15,0/20,0 Protective cap 15.0/20.0 | 0,03 | 581858000 |
|  gelb Länge: 6 cm Durchmesser: 6,7 cm | | |
| Vorlaufschlüssel 15,0 DK Positioning cone spanner 15.0 DK | 0,30 | 580579000 |
|  verzinkt Länge: 8 cm Schlüsselweite: 30 mm | | |
| Universal-Konusschlüssel 15,0/20,0 Universal cone spanner 15.0/20.0 | 0,90 | 581448000 |
|  verzinkt Länge: 9 cm Schlüsselweite: 50 mm | | |
| Ankerstabschlüssel 15,0/20,0 Tie-rod wrench 15.0/20.0 | 1,9 | 580594000 |
|  verzinkt Länge: 37 cm Durchmesser: 8 cm | | |

| | [kg] | Art.-Nr. |
|---|------|------------------|
| Freilaufknarre SW27 Friction type ratchet SW27 | 0,49 | 581855000 |
|  manganphosphatiert Länge: 30 cm | | |
| Steckschlüssel 27 0,65m Box spanner 27 0.65m | 1,9 | 581854000 |
|  verzinkt | | |
| Ankerlastanzeigergerät 300kN Form-tie load read-off device 300kN | 12,8 | 581834500 |
|  verzinkt | | |
| Ankersystem 20,0 | | |
| Ankerstab 20,0mm verzinkt 0,50m | 1,3 | 581411000 |
| Ankerstab 20,0mm verzinkt 0,75m | 1,9 | 581417000 |
| Ankerstab 20,0mm verzinkt 1,00m | 2,5 | 581412000 |
| Ankerstab 20,0mm verzinkt 1,25m | 3,2 | 581418000 |
| Ankerstab 20,0mm verzinkt 1,50m | 3,8 | 581413000 |
| Ankerstab 20,0mm verzinkt 2,00m | 5,0 | 581414000 |
| Ankerstab 20,0mm verzinkt 2,50m | 6,3 | 581430000 |
| Ankerstab 20,0mm verzinktm | 2,5 | 581410000 |
| Ankerstab 20,0mm unbehandelt 0,50m | 1,3 | 581405000 |
| Ankerstab 20,0mm unbehandelt 0,75m | 1,9 | 581416000 |
| Ankerstab 20,0mm unbehandelt 1,00m | 2,5 | 581406000 |
| Ankerstab 20,0mm unbehandelt 1,50m | 3,8 | 581407000 |
| Ankerstab 20,0mm unbehandelt 2,00m | 5,0 | 581408000 |
| Ankerstab 20,0mm unbehandeltm | 2,5 | 581403000 |
| Tie rod 20.0mm | | |
|  | | DIN 18216 |
| Flügelmutter 20,0 Wing nut 20.0 | 0,47 | 581466000 |
|  verzinkt Länge: 11 cm Höhe: 6 cm Schlüsselweite: 36 mm | | DIN 18216 |
| Sechskantmutter 20,0 Hexagon nut 20.0 | 0,60 | 581420000 |
|  verzinkt Länge: 7 cm Schlüsselweite: 41 mm | | DIN 18216 |
| Ankerplatte 20,0 Anchor plate 20.0 | 1,7 | 581425000 |
|  verzinkt | | DIN 18216 |
| Superplatte 20,0 B Super plate 20.0 B | 2,0 | 581424000 |
|  verzinkt Höhe: 7 cm Durchmesser: 14 cm Schlüsselweite: 34 mm | | DIN 18216 |

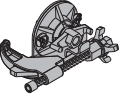
| | [kg] | Art.-Nr. |
|--|------|------------------|
| Framax-Kombimutter 20,0 Framax combination nut 20.0 | 6,1 | 588683000 |
|  verzinkt Breite: 27 cm | | |

| | | |
|--|-----|------------------|
| Framax-Ankermutter 20,0 Framax form-tie nut 20.0 | 3,6 | 588687000 |
|  verzinkt Breite: 19 cm | | |

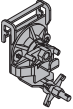
| | | |
|--|-----|------------------|
| Top100 tec-Ankermutter 20,0 Top100 tec form-tie nut 20.0 | 4,8 | 586934000 |
|  verzinkt Höhe: 25 cm | | |

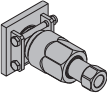
| | | |
|--|-----|------------------|
| Lösemutter 20,0 Quick-release nut 20.0 | 5,9 | 581428000 |
|  verzinkt Länge: 22 cm Einbauanleitung beachten! | | |

| | | |
|--|-----|----------------------------|
| Ankerkopf 20,0 She-bolt 20.0 | 5,6 | 581435000 |
|  verzinkt Länge: 140 cm Durchmesser: 5 cm Schlüsselweite: 41 mm | | DIN 18216 |

| | | |
|---|-----|----------------------------|
| Ankerkonus 20,0 Anchoring cone 20.0 | 1,0 | 581437000 |
|  verzinkt Länge: 15 cm Durchmesser: 5 cm Werkzeug: Konusschlüssel 20,0 | | DIN 18216 |

| | | |
|--|------|------------------|
| Dichtungshülse 20,0 Sealing sleeve 20.0 | 0,03 | 581441000 |
|  grau Länge: 16 cm Durchmesser: 5 cm | | |

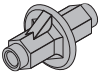
| | | |
|--|-----|------------------|
| Wasserstopp 20,0 Water stop connector 20.0 | 1,3 | 581467000 |
|  unbehandelt Länge: 14 cm | | |

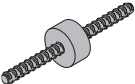
| | | |
|--|-----|------------------|
| Wassersperre 20,0 33cm Water stop 20.0 33cm | 1,7 | 581426000 |
|  unbehandelt Länge: 33 cm Durchmesser: 8 cm Sonderlängen können unter der Sonder-Art.-Nr. 580100000 unter Angabe der Bezeichnung und der gewünschten Länge in mm bestellt werden. | | |

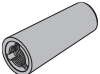
| | | |
|--|-----|------------------|
| Universal-Kletterkonus 20,0 Universal climbing cone 20.0 | 1,2 | 581442000 |
|  verzinkt Länge: 13 cm Durchmesser: 5 cm Werkzeug: Universal-Konusschlüssel 15,0/20,0 | | |

| | [kg] | Art.-Nr. |
|---|------|------------------|
| Konusschraube B 7cm Cone screw B 7cm | 0,86 | 581444000 |
|  rot Länge: 10 cm Durchmesser: 7 cm Schlüsselweite: 50 mm | | |

| | | |
|---|------|------------------|
| Dichtungshülse K 20,0 Sealing sleeve K 20.0 | 0,03 | 581443000 |
|  gelbgrün Länge: 12 cm Durchmesser: 6 cm | | |

| | | |
|--|----------------------|--|
| Faserbetonstopfen 27mm Faserbetonstopfen 35mm Faserbetonstopfen 40mm Fibre concrete plug | 0,03 0,11 0,14 | 581473000 588923000 588924000 |
|  grau | | |

| | | |
|--|------|------------------|
| Betonkonus 52mm Concrete cone 52mm | 0,19 | 581939000 |
|  grau | | |

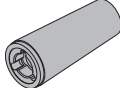
| | | |
|---|-----|------------------|
| Sichtbetonvorlauf MF 20,0 Fair-faced concrete positioning cone MF 20.0 | 1,3 | 581469000 |
|  verzinkt Länge: 12,6 cm Durchmesser: 5,3 cm Werkzeug: Universal-Konusschlüssel 15,0/20,0 | | |

| | | |
|--|------|------------------|
| Vorlaufscheibe M30 Positioning disk M30 | 0,25 | 581975000 |
|  verzinkt Durchmesser: 9 cm | | |

| | | |
|---|------|------------------|
| Vorlaufklemme M30 Positioning clamp M30 | 0,19 | 581833000 |
|  verzinkt Durchmesser: 4 cm | | |

| | | |
|---|-----|------------------|
| Wellenanker 20,0 Pigtail anchor 20.0 | 2,0 | 581450000 |
|  unbehandelt Länge: 76 cm | | |

| | | |
|---|------|------------------|
| Sperranker 20,0 11,5cm 90 Stop anchor 20.0 11.5cm 90 | 0,88 | 581456000 |
|  unbehandelt | | |

| | | |
|---|------|------------------|
| Sperranker 20,0 17,5cm 55 Stop anchor 20.0 17.5cm 55 | 0,62 | 581457000 |
|  unbehandelt | | |

| | | |
|---|-----|------------------|
| Sperranker 20,0 40cm 55 Stop anchor 20.0 40cm 55 | 1,2 | 581458000 |
|  unbehandelt | | |

| | [kg] | Art.-Nr. |
|---|------|------------------|
| Sperranker beidseitig 20,0 19cm 90 Stop anchor double-ended 20.0 19cm 90 | 1,1 | 581459000 |
|  unbehandelt Sonderlängen können unter der Sonder-Art.-Nr. 580100000 unter Angabe der Bezeichnung und der gewünschten Länge in mm bestellt werden. | | |

| | | |
|--|------|------------------|
| Anschweißmuffe 20,0 Weldable coupler 20.0 | 0,55 | 581474000 |
|  unbehandelt Länge: 8 cm Durchmesser: 4 cm Einbauanleitung beachten! | | |

| | | |
|---|------|------------------|
| Verbindungsuffe 20,0 Rod connector 20.0 | 0,94 | 581421000 |
|  unbehandelt Länge: 15 cm Schlüsselweite: 36 mm | | |

| | | |
|---|-----|------------------|
| Felsanker-Spreizeinheit 20,0 Rock anchor spreader unit 20.0 | 1,3 | 581468000 |
|  verzinkt Länge: 11,9 cm Durchmesser: 5,7 cm Einbauanleitung beachten! | | |

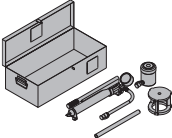
| | | |
|---|------|------------------|
| Vorspanngerät 300kN Tensioning instrument 300kN | 32,0 | 581815000 |
|  verzinkt | | |

| | | |
|--|------|------------------|
| Kunststoffrohr 26mm 2,00m Plastic tube 26mm 2.00m | 0,59 | 581463000 |
|  | | |

| | | |
|---|-------|------------------|
| Universal-Konus 26mm Universal cone 26mm | 0,008 | 581464000 |
|  grau Durchmesser: 5 cm | | |

| | | |
|--|-------|------------------|
| Verschlussstopfen 26mm Plug 26mm | 0,006 | 581465000 |
|  grau | | |

| | | |
|--|-----|------------------|
| Faserbetonrohr 27mm 1,25m Fibre concrete tube 27mm 1.25m | 2,6 | 581472000 |
|  | | |

| | | |
|--|------|------------------|
| Schutzkappe 15,0/20,0 Protective cap 15.0/20.0 | 0,03 | 581858000 |
|  gelb Länge: 6 cm Durchmesser: 6,7 cm | | |

| | | |
|---|-----|------------------|
| Konusschlüssel 20,0 Cone spanner 20.0 | 3,5 | 581471000 |
|  verzinkt Länge: 57 cm | | |

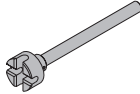
| | [kg] | Art.-Nr. |
|---|------|------------------|
| Ankerstabschlüssel 15,0/20,0 Tie-rod wrench 15.0/20.0 | 1,9 | 580594000 |
|  verzinkt Länge: 37 cm Durchmesser: 8 cm | | |

| | | |
|--|------|------------------|
| Universal-Konusschlüssel 15,0/20,0 Universal cone spanner 15.0/20.0 | 0,90 | 581448000 |
|  verzinkt Länge: 9 cm Schlüsselweite: 50 mm | | |

| | | |
|--|-----|------------------|
| Schlag-Ringschlüssel 70 Slugging ring spanner 70 | 2,6 | 581429000 |
|  Länge: 32 cm | | |

| | | |
|---|-----|------------------|
| Doppelanker 20,0 Double anchor 20.0 | 3,0 | 581432000 |
|  blau Breite: 35,3 cm | | |

| | | |
|---|------|------------------|
| Ankerhalter 20,0 Anchor holder 20.0 | 0,43 | 581427000 |
|  unbehandelt | | |

| | | |
|---|------|------------------|
| Freistellkonus 20,0 Clearance cone 20.0 | 0,49 | 581866000 |
|  schwarz gelb Länge: 20,6 cm Durchmesser: 7 cm Einbauanleitung beachten! | | |

| | | |
|---|------|------------------|
| Lösewerkzeug Freistellkonus Clearance-cone dismantling tool | 0,67 | 581864000 |
|  verzinkt Länge: 10,7 cm Schlüsselweite: 24 mm | | |

| | | |
|--|------|------------------|
| Ankerlastanzeigergerät 300kN Form-tie load read-off device 300kN | 12,8 | 581834500 |
|  verzinkt | | |

Ankersystem 26,5

| | | |
|---|-----|------------------|
| Ankerstab 26,5mm unbehandeltm Tie rod 26.5mm non-treatedm | 4,5 | 581883000 |
|---|-----|------------------|







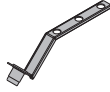

DIN
18216

| | | |
|--|------|------------------|
| Sechskantmutter 26,5 Hexagon nut 26.5 | 0,73 | 581985000 |
|  verzinkt Länge: 8 cm Schlüsselweite: 46 mm | | |

DIN
18216

| | [kg] | Art.-Nr. |
|--|-------|------------------|
| Ankerplatte 26,5 Anchor plate 26.5 | 3,4 | 581986000 |
|  verzinkt Länge: 15 cm Breite: 12 cm | | DIN 18216 |
| Universal-Kletterkonus 26,5 Universal climbing cone 26.5 | 1,1 | 581987000 |
|  verzinkt Länge: 12,6 cm Durchmesser: 5 cm Werkzeug: Universal-Konusschlüssel 15,0/20,0 | | |
| Konusschraube B 7cm Cone screw B 7cm | 0,86 | 581444000 |
|  rot Länge: 10 cm Durchmesser: 7 cm Schlüsselweite: 50 mm | | |
| Dichtungshülse K 26,5 Sealing sleeve K 26.5 | 0,02 | 581998000 |
|  lichtblau Länge: 11 cm Durchmesser: 6 cm | | |
| Verbindungsuffe 26,5 Rod connector 26.5 | 1,4 | 581988000 |
|  unbehandelt Länge: 15 cm Schlüsselweite: 46 mm | | DIN 18216 |
| Wellenanker 26,5 Pigtail anchor 26.5 | 3,6 | 581900000 |
|  unbehandelt Länge: 80 cm | | |
| Kunststoffrohr 32mm 2,00m Plastic tube 32mm 2.00m | 0,60 | 581460000 |
|  Durchmesser: 4 cm | | |
| Universal-Konus 32mm Universal cone 32mm | 0,008 | 581461000 |
|  grau Durchmesser: 5 cm | | |
| Universal-Konusschlüssel 15,0/20,0 Universal cone spanner 15.0/20.0 | 0,90 | 581448000 |
|  verzinkt Länge: 9 cm Schlüsselweite: 50 mm | | |
| Betonkonus 52mm Concrete cone 52mm | 0,19 | 581939000 |
|  grau | | |
| Ankerstabschlüssel 20,0/26,5 Tie-rod wrench 20.0/26.5 | 1,7 | 580593000 |
|  verzinkt Länge: 37 cm Durchmesser: 8 cm | | |
| Doppelanker 26,5 Double anchor 26.5 | 4,8 | 581433000 |
|  grün Breite: 36 cm | | |

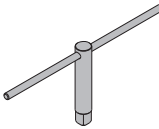
| | [kg] | Art.-Nr. |
|---|------|------------------|
| Ankerhalter 26,5 Anchor holder 26.5 | 0,43 | 581943000 |
|  unbehandelt | | |
| Freistellkonus 26,5 Clearance cone 26.5 | 0,46 | 581867000 |
|  schwarz grau Länge: 20,6 cm Durchmesser: 7 cm Einbauanleitung beachten! | | |
| Lösewerkzeug Freistellkonus Clearance-cone dismantling tool | 0,67 | 581864000 |
|  verzinkt Länge: 10,7 cm Schlüsselweite: 24 mm | | |
| Ankersystem 32,0 | | |
| Ankerstab 32,0mm unbehandeltm Tie rod 32.0mm non-treatedm | 6,5 | 582914000 |
|  | | |
| Sechskantmutter 32,0 Hexagon nut 32.0 | 1,8 | 582915000 |
|  unbehandelt Länge: 9 cm Schlüsselweite: 55 mm | | |
| Ankerplatte 32,0 Anchor plate 32.0 | 4,1 | 582916000 |
|  unbehandelt Länge: 15 cm Breite: 15 cm | | |
| Ankerkonus 32,0 Anchoring cone 32.0 | 7,7 | 582917000 |
|  verzinkt Länge: 22,5 cm Durchmesser: 10 cm | | |
| Vierkantschlüssel 32,0 Square spanner 32.0 | 5,3 | 582918000 |
|  verzinkt Länge: 59 cm | | |