

	[kg]	Art.-Nr.
Fertigelement FL20 2,50x2,65m 27mm	427,0	587365000
Fertigelement FL20 2,00x2,65m 27mm	345,0	587364000
Fertigelement FL20 1,25x2,65m 27mm	220,0	587363000
Fertigelement FL20 1,00x2,65m 27mm	175,0	587362000
Fertigelement FL20 0,75x2,65m 27mm	140,0	587361000
Fertigelement FL20 0,50x2,65m 27mm	99,0	587360000
Fertigelement FL20 2,50x1,00m 27mm	240,0	587375000
Fertigelement FL20 2,00x1,00m 27mm	194,0	587374000
Fertigelement FL20 1,25x1,00m 27mm	125,0	587373000
Fertigelement FL20 1,00x1,00m 27mm	99,0	587372000
Fertigelement FL20 0,75x1,00m 27mm	80,0	587371000
Fertigelement FL20 0,50x1,00m 27mm	59,0	587370000
Fertigelement FL20 2,50x0,50m 27mm	70,0	587385000
Fertigelement FL20 2,00x0,50m 27mm	57,0	587384000
Fertigelement FL20 1,25x0,50m 27mm	46,0	587383000
Fertigelement FL20 1,00x0,50m 27mm	20,0	587382000
Fertigelement FL20 0,75x0,50m 27mm	25,0	587381000
Fertigelement FL20 0,50x0,50m 27mm	29,5	587380000
Formwork element FL20 27mm		

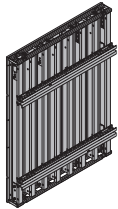

Innenecke FL20 2,65m 27mm	180,0	587366000
Innenecke FL20 1,00m 27mm	101,0	587376000
Innenecke FL20 0,50m 27mm	38,0	587386000
Inside corner FL20 27mm		



Inneneckriegel U100 L50 0,50m	13,9	587172000
Inside corner waling U100 L50 0.50m		
blau lackiert		

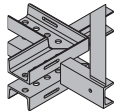

Gelenkinnenecke L 2,65m	240,0	587179000
Gelenkinnenecke L 1,00m	110,0	587176000
Swivelling inside corner L		



Gelenkaußenecke L 2,65m	95,5	587185000
Swivelling outside corner L 2.65m		
blau pulverbeschichtet		

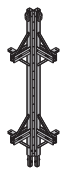

	[kg]	Art.-Nr.
Framax-Ausschalecke I 2,70m	171,0	588675000
Framax-Ausschalecke I 1,35m	90,0	588614000
Framax-Ausschalecke I 3,30m	209,9	588676000
Framax stripping corner I		

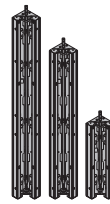

verzinkt, pulverbeschichtet

Framax-Ausschalspindel I	3,2	588618000
Framax stripping spindle I		



verzinkt
Höhe: 25 cm

Framax-Ausschalspindel I mit Ratsche	5,5	588653000
Framax stripping spindle I with ratchet		



verzinkt
Höhe: 24,8 cm

Framax-Schnellspanner RU	3,3	588153400
Framax quick acting clamp RU		



verzinkt
Länge: 20 cm

Verbinderlasche L 9cm	4,1	587174000
Formwork connector L 9cm		



blau lackiert

Verbinderlasche LZ 9cm	7,5	587165000
Formwork connector LZ 9cm		

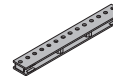

blau lackiert

Übergangslasche CH 27mm	17,0	587166000
Transition plate CH 27mm		

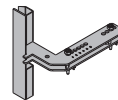

blau lackiert

Ausgleichslasche 80 L 9cm	8,0	587178000
Adjustable waling extension 80 L 9cm		

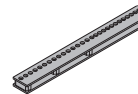

blau lackiert

Ausgleichslasche 120 L 9cm	12,2	587180000
Adjustable waling extension 120 L 9cm		

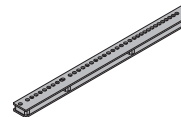

blau lackiert

Stirnlasche L 15,0 9cm	4,4	587184000
Front anchoring plate L 15.0 9cm		

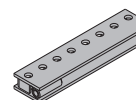

blau lackiert

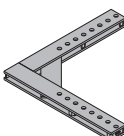
	[kg]	Art.-Nr.
Außenecklasche L 50 Outside angle plate L 50	20,5	587410000
		blau lackiert

Innenecklasche L 50 Internal angle plate L 50	5,2	587409000
		blau lackiert

Ecklasche GL Corner plate GL	4,8	587175000
		blau lackiert

Aufstockwinkel FF20 Stacking angle FF20	7,8	587547000
		blau lackiert Höhe: 46 cm

Spannbolzen FF20 Fastening bolt FF20	0,30	587545000
		verzinkt Länge: 17 cm Schlüsselweite: 30 mm

Sternmutter 15,0 G Star grip nut 15.0 G	0,47	587544000
		verzinkt Breite: 10 cm Höhe: 5 cm Schlüsselweite: 30 mm

Universal-Winkelspanner CH Universal angle tie bracket CH	4,5	587408000
		blau lackiert

Außenwinkel L Outside angle L	3,1	587355000
		

Trägerklammer L Beam clamp L	1,3	587322000
		

Verbindungsbolzen 10cm Connecting pin 10cm	0,34	580201000
		verzinkt Länge: 14 cm

Federvorstecker 5mm Spring cotter 5mm	0,05	580204000
		verzinkt Länge: 13 cm

	[kg]	Art.-Nr.
Flanschklammer H20 Flange clamp H20	1,0	580135000
		verzinkt Breite: 13 cm Schlüsselweite: 19 mm

Mehrzweckriegel WS10 Top50 0,50m	10,2	580001000
Mehrzweckriegel WS10 Top50 0,75m	14,9	580002000
Mehrzweckriegel WS10 Top50 1,00m	19,6	580003000
Mehrzweckriegel WS10 Top50 1,25m	24,7	580004000
Mehrzweckriegel WS10 Top50 1,50m	29,7	580005000
Mehrzweckriegel WS10 Top50 1,75m	35,0	580006000
Mehrzweckriegel WS10 Top50 2,00m	38,9	580007000
Mehrzweckriegel WS10 Top50 2,25m	44,2	580008000
Mehrzweckriegel WS10 Top50 2,50m	48,7	580009000
Mehrzweckriegel WS10 Top50 2,75m	54,2	580010000
Mehrzweckriegel WS10 Top50 3,00m	58,9	580011000
Mehrzweckriegel WS10 Top50 3,50m	68,4	580012000
Mehrzweckriegel WS10 Top50 4,00m	79,4	580013000
Mehrzweckriegel WS10 Top50 4,50m	89,1	580014000
Mehrzweckriegel WS10 Top50 5,00m	102,0	580015000
Mehrzweckriegel WS10 Top50 5,50m	112,4	580016000
Mehrzweckriegel WS10 Top50 6,00m	118,0	580017000

Multi-purpose waling WS10 Top50		blau lackiert
		

Stahlwandriegel U100 L50 0,50m	12,3	587188000
Stahlwandriegel U100 L50 0,75m	17,3	587189000
Stahlwandriegel U100 L50 1,00m	22,4	587190000
Stahlwandriegel U100 L50 1,25m	27,1	587191000
Stahlwandriegel U100 L50 K 1,50m	31,3	587404000
Stahlwandriegel U100 L50 1,75m	37,5	587193000
Stahlwandriegel U100 L50 2,00m	43,1	587194000
Stahlwandriegel U100 L50 2,25m	46,8	587195000
Stahlwandriegel U100 L50 2,50m	52,7	587196000
Stahlwandriegel U100 L50 2,75m	56,8	587197000
Stahlwandriegel U100 L50 3,00m	63,5	587198000

Steel waling U100 L50		blau lackiert
		

Eckschiene 3,00m	53,0	580282000
Eckschiene 4,00m	69,0	580284000

Inside corner plate
blau pulverbeschichtet



Aussparungsklemme 24cm	3,3	580063000
Aussparungsklemme 25cm	3,4	580064000
Aussparungsklemme 30cm	3,8	580065000

Box-out clamp
verzinkt
Schenkellänge: 10 cm

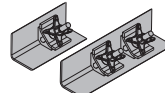

	[kg]	Art.-Nr.
Aussparungsklemme Typ 1cm	20,0	580066000
Aussparungsklemme Typ 2cm	17,4	580067000
Box-out clampcm		

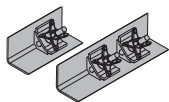

blau lackiert
Schenkellänge: 10 cm

Elementstütze 340 IB	24,3	580365000
-----------------------------	------	------------------

Panel strut 340 IB

bestehend aus:

(A) Justierstütze 340 IB	16,7	588696000
---------------------------------	------	------------------

verzinkt
Länge: 190,8 - 341,8 cm

(B) Justierstrebe 120 IB	7,6	588248500
---------------------------------	-----	------------------

verzinkt
Länge: 81,5 - 130,6 cm

verzinkt
Lieferzustand: zusammengeklappt

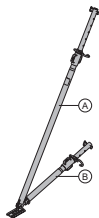

Elementstütze 540 IB	41,4	580366000
-----------------------------	------	------------------

Panel strut 540 IB

bestehend aus:

(A) Justierstütze 540 IB	30,7	588697000
---------------------------------	------	------------------

verzinkt
Länge: 310,5 - 549,2 cm

(B) Justierstrebe 220 IB	10,9	588251500
---------------------------------	------	------------------

verzinkt
Länge: 172,5 - 221,1 cm

verzinkt
Lieferzustand: zusammengeklappt

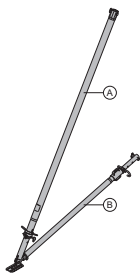

Eurex 60 550

Eurex 60 550

je nach erforderlicher Länge bestehend aus:

(A) Justierstütze Eurex 60 550	42,5	582658000
---------------------------------------	------	------------------

blau pulverbeschichtet
Alu

Länge: 343 - 553 cm

(B) Verlängerung Eurex 60 2,00m	21,3	582651000
--	------	------------------

blau pulverbeschichtet

Alu

Länge: 250 cm

(C) Kupplungsstück Eurex 60	8,6	582652000
------------------------------------	-----	------------------

Alu

Länge: 100 cm

Durchmesser: 12,8 cm

(D) Verbindungsstück Eurex 60 IB	4,2	582657500
---	-----	------------------

verzinkt

Länge: 15 cm

Breite: 15 cm

Höhe: 30 cm

(E) Justierstützenfuß Eurex 60 EB	8,0	582660500
--	-----	------------------

verzinkt

Länge: 31 cm

Breite: 12 cm

Höhe: 33 cm

(F) Justierstrebe 540 Eurex 60 IB	27,8	582659500
--	------	------------------

verzinkt

Länge: 303,5 - 542,2 cm

Lieferzustand: Einzelteile

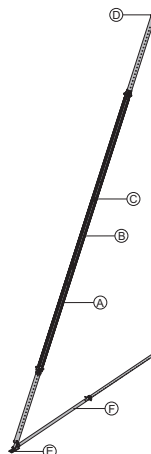

Stützenkopf EB

Prop head EB

3,1 **588244500**



verzinkt

Länge: 40,8 cm

Breite: 11,8 cm

Höhe: 17,6 cm

Universal-Lösewerkzeug

Universal dismantling tool

3,7 **582768000**

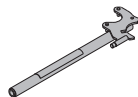

verzinkt

Länge: 75,5 cm

Doka-Expressanker 16x125mm

Doka express anchor 16x125mm

0,31 **588631000**



verzinkt

Länge: 18 cm

Einbauanleitung beachten!

Doka-Coil 16mm

Doka coil 16mm

0,009 **588633000**



verzinkt

Durchmesser: 1,6 cm

	[kg]	Art.-Nr.
Lehre Doka-Expressanker 16x125mm Gauge for Doka express anchor 16x125mm	0,03	588632000
 schwarz Länge: 3 cm Durchmesser: 2 cm		

Betonierkonsole L Top scaffold bracket L	12,6	587153500
 verzinkt Länge: 101 cm Höhe: 159 cm		

Universal-Konsole 60 Universal bracket 60	14,0	580477000
 verzinkt Länge: 86 cm Höhe: 181 cm		

Universal-Konsole 90 Universal bracket 90	30,4	580476000
 verzinkt Länge: 121 cm Höhe: 235 cm		

Universal-Eckkonsole 90 rechts Universal-Eckkonsole 90 links Universal corner bracket 90	29,5 29,5	580071000 580070000
 verzinkt Länge: 152 cm Höhe: 235 cm		

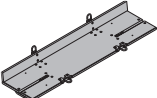
Konsolenbelag 60/250cm Konsolenbelag 90/250cm Bracket planking	48,5 61,3	583029000 583031000
 Stahlteile verzinkt Holzteile gelb lasiert		

Konsolengeländer 240-270cm Bracket railing 240-270cm	22,5	583032000
 verzinkt		

Universal-Geländerbügel Universal railing shackle	3,0	580478000
 verzinkt Höhe: 20 cm		

	[kg]	Art.-Nr.
Gerüstrohr 48,3mm 0,50m	1,7	682026000
Gerüstrohr 48,3mm 1,00m	3,6	682014000
Gerüstrohr 48,3mm 1,50m	5,4	682015000
Gerüstrohr 48,3mm 2,00m	7,2	682016000
Gerüstrohr 48,3mm 2,50m	9,0	682017000
Gerüstrohr 48,3mm 3,00m	10,8	682018000
Gerüstrohr 48,3mm 3,50m	12,6	682019000
Gerüstrohr 48,3mm 4,00m	14,4	682021000
Gerüstrohr 48,3mm 4,50m	16,2	682022000
Gerüstrohr 48,3mm 5,00m	18,0	682023000
Gerüstrohr 48,3mm 5,50m	19,8	682024000
Gerüstrohr 48,3mm 6,00m	21,6	682025000
Gerüstrohr 48,3mmm	3,6	682001000
Scaffold tube 48.3mm		

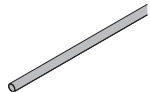
 verzinkt		
--	--	--

Gerüstrohranschluss Scaffold tube connection	0,27	584375000
 verzinkt Höhe: 7 cm		

Anschraubkupplung 48mm 50 Screw-on coupler 48mm 50	0,84	682002000
 verzinkt Schlüsselweite: 22 mm Einbauanleitung beachten!		

Framax-Betonierbühne U 1,25/2,70m Framax pouring platform U 1.25/2.70m	127,5	588377000
 Stahlteile verzinkt Holzteile gelb lasiert Lieferzustand: zusammengeklappt		

FF20-Adapter für Framax-Betonierbühne U FF20 adapter for Framax pouring platform U	6,8	588381000
 verzinkt Länge: 34 cm		

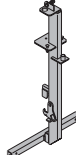
Top50-Adapter für Framax-Betonierbühne U Top50 adapter for Framax pouring platform U	18,5	588384000
 verzinkt Breite: 75 cm Höhe: 134 cm		

Geländersteher XP 1,20m Handrail post XP 1.20m	4,1	586460000
 verzinkt Höhe: 118 cm		

Fußwehrhalter XP 1,20m Toeboard holder XP 1.20m	0,64	586461000
 verzinkt Höhe: 21 cm		

	[kg]	Art.-Nr.
Geländerzwinge XP 40cm Railing clamp XP 40cm	7,7	586456000
 verzinkt Höhe: 73 cm		

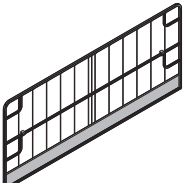
Schutzgitter XP 2,70x1,20m	22,2	586450000
Schutzgitter XP 2,50x1,20m	20,5	586451000
Schutzgitter XP 2,00x1,20m	17,4	586452000
Schutzgitter XP 1,20x1,20m	12,0	586453000
Protective grating XP		
 verzinkt		

Klettverschluss 30x380mm Velcro fastener 30x380mm	0,02	586470000
 gelb		

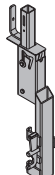
Trägerschalungsadapter XP Timber-beam formwork adapter XP	9,5	586476000
 verzinkt Höhe: 83,5 cm		

Schutzgeländerzwinge S Handrail clamp S	11,5	580470000
 verzinkt Höhe: 123 - 171 cm		

Schutzgeländerzwinge T Handrail clamp T	12,3	584381000
 verzinkt Höhe: 122 - 155 cm		

Schutzgeländer 1,10m Handrail post 1.10m	5,5	584384000
 verzinkt Höhe: 134 cm		

	[kg]	Art.-Nr.
Steckhülse 24mm Attachable sleeve 24mm	0,03	584385000
 grau Länge: 16,5 cm Durchmesser: 2,7 cm		

Schraubhülse 20,0 Screw sleeve 20.0	0,03	584386000
 gelb Länge: 20 cm Durchmesser: 3,1 cm		

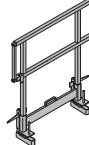
Seitenschutzgeländer T Side handrail clamping unit T	29,1	580488000
 verzinkt Länge: 115 - 175 cm Höhe: 112 cm		

Doka-Vierstrangkette 3,20m Doka 4-part chain 3.20m	15,0	588620000
 Betriebsanleitung beachten!		CE

Anschlagkette 100cm 15kN Lifting chain 100cm 15kN	1,8	587548000
 Länge: 103 cm Betriebsanleitung beachten!		CE

Dokamatic-Umsetzgurt 13,00m Dokamatic lifting strap 13.00m	10,5	586231000
 grün Betriebsanleitung beachten!		CE

Kranöse Lifting bracket	6,2	580460000
 verzinkt Höhe: 59 cm		

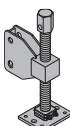
Höhenjustierung WS10-WU16 Height adjuster WS10-WU16	10,1	580206500
 verzinkt Höhe: 45 cm		

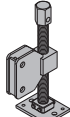
Höhenjustierung für Mehrzweckriegel Height adjuster for multi-purpose walings	10,3	580206000
 verzinkt Höhe: 45 cm		

[kg] Art.-Nr.

[kg] Art.-Nr.

Anhängewinkel Typ A

Tie-off connector type A

0,96 **581641000**



verzinkt
Länge: 13,7 cm

Doka-Auffanggurt

Doka personal fall-arrest set

3,6 **583022000**



Betriebsanleitung beachten!

