

	[kg]	Art.-Nr.
Fertigelement FF20 2,00x2,75m 21mm	335,0	587512000
Fertigelement FF20 1,00x2,75m 21mm	166,0	587508000
Fertigelement FF20 0,75x2,75m 21mm	131,0	587504000
Fertigelement FF20 0,50x2,75m 21mm	92,0	587500000
Fertigelement FF20 2,00x1,00m 21mm	190,0	587523000
Fertigelement FF20 1,00x1,00m 21mm	95,0	587522000
Fertigelement FF20 0,75x1,00m 21mm	79,5	587521000
Fertigelement FF20 0,50x1,00m 21mm	58,0	587520000
Fertigelement FF20 2,00x3,75m 21mm	440,0	587564000
Fertigelement FF20 1,00x3,75m 21mm	224,0	587562000
Fertigelement FF20 0,75x3,75m 21mm	172,0	587561000
Fertigelement FF20 0,50x3,75m 21mm	120,0	587560000
Fertigelement FF20 2,00x6,50m 21mm	692,0	587563000
Fertigelement FF20 1,00x6,50m 21mm	346,0	587565000
Fertigelement FF20 0,75x6,50m 21mm	272,0	587566000
Fertigelement FF20 0,50x6,50m 21mm	189,5	587567000

Formwork element FF20 21mm

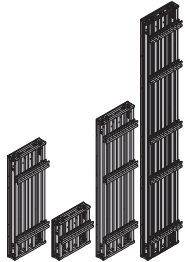

Fertigelement FF20 2,00x2,75m 27mm	348,0	587606000
Fertigelement FF20 1,00x2,75m 27mm	173,0	587604000
Fertigelement FF20 0,75x2,75m 27mm	136,0	587602000
Fertigelement FF20 0,50x2,75m 27mm	96,0	587600000
Fertigelement FF20 2,00x1,00m 27mm	195,0	587616000
Fertigelement FF20 1,00x1,00m 27mm	103,0	587614000
Fertigelement FF20 0,75x1,00m 27mm	81,5	587612000
Fertigelement FF20 0,50x1,00m 27mm	59,5	587610000

Formwork element FF20 27mm

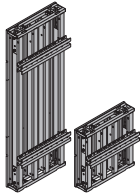

Aufstoeckelement FF20 2,00x0,50m 21mm	90,5	587529000
Aufstoeckelement FF20 1,00x0,50m 21mm	45,4	587528000
Aufstoeckelement FF20 0,75x0,50m 21mm	36,4	587527000
Aufstoeckelement FF20 0,50x0,50m 21mm	27,5	587526000

Stacking element FF20 21mm



Aufstoeckelement FF20 2,00x0,50m 27mm	67,5	587626000
Aufstoeckelement FF20 1,00x0,50m 27mm	33,4	587624000
Aufstoeckelement FF20 0,75x0,50m 27mm	28,8	587622000
Aufstoeckelement FF20 0,50x0,50m 27mm	21,0	587620000

Stacking element FF20 27mm



Innenecke FF20 2,75m 21mm	214,0	587516000
Innenecke FF20 1,00m 21mm	117,0	587525000

Inside corner FF20 21mm

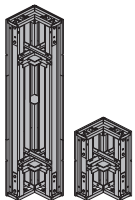

Innenecke FF20 2,75m 27mm	220,0	587608000
Innenecke FF20 1,00m 27mm	120,0	587618000
Innenecke FF20 0,50m 27mm	33,5	587628000

Inside corner FF20 27mm

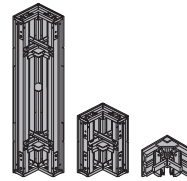

Gelenkinnenecke FF20 2,75m 21mm	246,5	587577000
Gelenkinnenecke FF20 1,00m 21mm	103,0	587575000
Gelenkinnenecke FF20 0,50m 21mm	53,7	587573000

Swivelling inside corner FF20 21mm

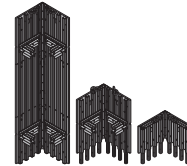

Gelenkinnenecke FF20 0,50m 27mm	55,0	587647000
Gelenkinnenecke FF20 1,00m 27mm	108,8	587649000
Gelenkinnenecke FF20 2,75m 27mm	255,0	587651000

Swivelling inside corner FF20 27mm

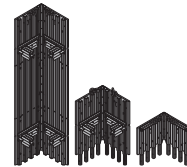

Gelenkaußenecke FF20 2,75m 21mm	102,7	587579000
Gelenkaußenecke FF20 1,00m 21mm	46,2	587578000

Swivelling outside corner FF20 21mm

blau lackiert

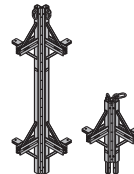

Gelenkaußenecke FF20 2,75m 27mm	102,7	587654000
Gelenkaußenecke FF20 1,00m 27mm	46,2	587653000

Swivelling outside corner FF20 27mm

blau lackiert

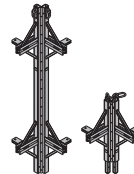

Gelenkaußenecke FF20 0,50m	16,1	587652000
----------------------------	------	-----------

Swivelling outside corner FF20 0.50m

blau lackiert



Ecklasche FF20 G	7,2	587571000
------------------	-----	-----------

Corner plate FF20 G

blau lackiert

Länge: 49 cm

Breite: 24 cm

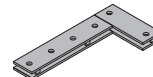



	[kg]	Art.-Nr.
Spannbolzen FF20 Fastening bolt FF20	0,30	587545000
	verzinkt Länge: 17 cm Schlüsselweite: 30 mm	

Sternmutter 15,0 G Star grip nut 15.0 G	0,47	587544000
	verzinkt Breite: 10 cm Höhe: 5 cm Schlüsselweite: 30 mm	

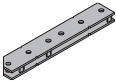
Elementverbinder FF20/50 Formwork element connector FF20/50	6,3	587530000
	blau lackiert Länge: 55 cm	

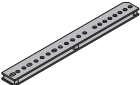
Elementverbinder FF20/50 Z Formwork element connector FF20/50 Z	6,0	587533000
	blau lackiert Länge: 55 cm	

Ausgleichslasche FF20/50 Adjustable waling extension FF20/50	9,1	587532000
	blau lackiert Länge: 87 cm	

Trägerklammer Top50 Beam clamp Top50	1,2	580081000
	blau lackiert Höhe: 15 cm	

Ankerungslasche FF20/50 Anchoring plate FF20/50	6,6	587531000
	blau lackiert Länge: 55 cm	

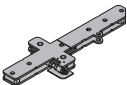
Verbindungslasche mit Fugenjustierung Splice plate with join adjustment	13,8	580215000
	blau lackiert Länge: 76 cm	

Verteilerplatte FF20 Distribution plate FF20	1,7	580216000
	verzinkt Breite: 10,9 cm Höhe: 12 cm	

Versatzlasche FF20 Offset plate FF20	6,2	587534000
	blau lackiert Länge: 35 cm Breite: 18 cm Höhe: 4 cm	

Außenecklasche FF20 21mm	18,6	587535000
Außenecklasche FF20 27mm	18,6	587634000

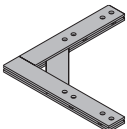
Außenecklasche FF20 Outside angle plate FF20		
	blau lackiert Schenkellänge: 60 cm	

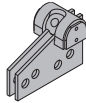
	[kg]	Art.-Nr.
Universal-Winkelspanner Universal angle tie bracket	4,4	580604000
	blau lackiert Länge: 20 cm	

Verbindungsbolzen 10cm Connecting pin 10cm	0,34	580201000
	verzinkt Länge: 14 cm	

Federvorstecker 5mm Spring cotter 5mm	0,05	580204000
	verzinkt Länge: 13 cm	

Flanschklammer H20 Flange clamp H20	1,0	580135000
	verzinkt Breite: 13 cm Schlüsselweite: 19 mm	

Aufstockwinkel FF20 Stacking angle FF20	7,8	587547000
	blau lackiert Höhe: 46 cm	

Mehrzweckriegel WS10 Top50 0,50m	10,2	580001000
Mehrzweckriegel WS10 Top50 0,75m	14,9	580002000
Mehrzweckriegel WS10 Top50 1,00m	19,6	580003000
Mehrzweckriegel WS10 Top50 1,25m	24,7	580004000
Mehrzweckriegel WS10 Top50 1,50m	29,7	580005000
Mehrzweckriegel WS10 Top50 1,75m	35,0	580006000
Mehrzweckriegel WS10 Top50 2,00m	38,9	580007000
Mehrzweckriegel WS10 Top50 2,25m	44,2	580008000
Mehrzweckriegel WS10 Top50 2,50m	48,7	580009000
Mehrzweckriegel WS10 Top50 2,75m	54,2	580010000
Mehrzweckriegel WS10 Top50 3,00m	58,9	580011000
Mehrzweckriegel WS10 Top50 3,50m	68,4	580012000
Mehrzweckriegel WS10 Top50 4,00m	79,4	580013000
Mehrzweckriegel WS10 Top50 4,50m	89,1	580014000
Mehrzweckriegel WS10 Top50 5,00m	102,0	580015000
Mehrzweckriegel WS10 Top50 5,50m	112,4	580016000
Mehrzweckriegel WS10 Top50 6,00m	118,0	580017000

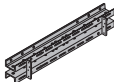
Mehrzweckriegel WS10 Top50 Multi-purpose waling WS10 Top50		
	blau lackiert	

Aussparungsklemme 24cm	3,3	580063000
Aussparungsklemme 25cm	3,4	580064000
Aussparungsklemme 30cm	3,8	580065000

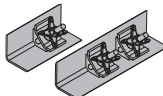
Aussparungsklemme Box-out clamp		
	verzinkt Schenkellänge: 10 cm	

Aussparungsklemme Typ 1cm	20,0	580066000
Aussparungsklemme Typ 2cm	17,4	580067000

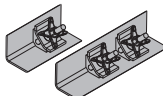
Aussparungsklemme Typ 1cm Box-out clampcm		
	blau lackiert Schenkellänge: 10 cm	

	[kg]	Art.-Nr.
Auflagewinkel Wandschalung Wall-formwork support angle	6,6	588967000
 verzinkt Länge: 15,8 cm Breite: 12 cm Höhe: 11,2 cm		

Elementstütze 340 IB Panel strut 340 IB	24,3	580365000
bestehend aus:		
(A) Justierstütze 340 IB verzinkt Länge: 190,8 - 341,8 cm	16,7	588696000
(B) Justierstrebe 120 IB verzinkt Länge: 81,5 - 130,6 cm	7,6	588248500

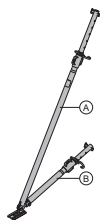

verzinkt
Lieferzustand: zusammengeklappt

Elementstütze 540 IB Panel strut 540 IB	41,4	580366000
bestehend aus:		
(A) Justierstütze 540 IB verzinkt Länge: 310,5 - 549,2 cm	30,7	588697000
(B) Justierstrebe 220 IB verzinkt Länge: 172,5 - 221,1 cm	10,9	588251500

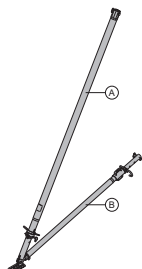

verzinkt
Lieferzustand: zusammengeklappt

Eurex 60 550 Eurex 60 550		
je nach erforderlicher Länge bestehend aus:		
(A) Justierstütze Eurex 60 550 blau pulverbeschichtet Alu Länge: 343 - 553 cm	42,5	582658000
(B) Verlängerung Eurex 60 2,00m blau pulverbeschichtet Alu Länge: 250 cm	21,3	582651000
(C) Kupplungsstück Eurex 60 Alu Länge: 100 cm Durchmesser: 12,8 cm	8,6	582652000
(D) Verbindungsstück Eurex 60 IB verzinkt Länge: 15 cm Breite: 15 cm Höhe: 30 cm	4,2	582657500
(E) Justierstützenfuß Eurex 60 EB verzinkt Länge: 31 cm Breite: 12 cm Höhe: 33 cm	8,0	582660500
(F) Justierstrebe 540 Eurex 60 IB verzinkt Länge: 303,5 - 542,2 cm	27,8	582659500

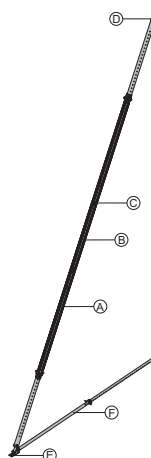

Lieferzustand: Einzelteile

Stützenkopf EB Prop head EB	3,1	588244500
---------------------------------------	-----	------------------



verzinkt
Länge: 40,8 cm
Breite: 11,8 cm
Höhe: 17,6 cm

Universal-Löswerkzeug Universal dismantling tool	3,7	582768000
--	-----	------------------

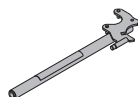

verzinkt
Länge: 75,5 cm

Doka-Expressanker 16x125mm Doka express anchor 16x125mm	0,31	588631000
---	------	------------------



verzinkt
Länge: 18 cm
Einbauanleitung beachten!

Doka-Coil 16mm Doka coil 16mm	0,009	588633000
---	-------	------------------





verzinkt
Durchmesser: 1,6 cm

	[kg]	Art.-Nr.
Lehre Doka-Expressanker 16x125mm Gauge for Doka express anchor 16x125mm	0,03	588632000
 schwarz Länge: 3 cm Durchmesser: 2 cm		

Betonierkonsole L Top scaffold bracket L	12,6	587153500
 verzinkt Länge: 101 cm Höhe: 159 cm		

Universal-Konsole 60 Universal bracket 60	14,0	580477000
 verzinkt Länge: 86 cm Höhe: 181 cm		

Universal-Konsole 90 Universal bracket 90	30,4	580476000
 verzinkt Länge: 121 cm Höhe: 235 cm		

Universal-Eckkonsole 90 rechts Universal-Eckkonsole 90 links Universal corner bracket 90	29,5 29,5	580071000 580070000
 verzinkt Länge: 152 cm Höhe: 235 cm		

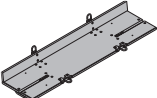
Konsolenbelag 60/250cm Konsolenbelag 90/250cm Bracket planking	48,5 61,3	583029000 583031000
 Stahlteile verzinkt Holzteile gelb lasiert		

Konsolengeländer 240-270cm Bracket railing 240-270cm	22,5	583032000
 verzinkt		

Universal-Geländerbügel Universal railing shackle	3,0	580478000
 verzinkt Höhe: 20 cm		

	[kg]	Art.-Nr.
Gerüstrohr 48,3mm 0,50m	1,7	682026000
Gerüstrohr 48,3mm 1,00m	3,6	682014000
Gerüstrohr 48,3mm 1,50m	5,4	682015000
Gerüstrohr 48,3mm 2,00m	7,2	682016000
Gerüstrohr 48,3mm 2,50m	9,0	682017000
Gerüstrohr 48,3mm 3,00m	10,8	682018000
Gerüstrohr 48,3mm 3,50m	12,6	682019000
Gerüstrohr 48,3mm 4,00m	14,4	682021000
Gerüstrohr 48,3mm 4,50m	16,2	682022000
Gerüstrohr 48,3mm 5,00m	18,0	682023000
Gerüstrohr 48,3mm 5,50m	19,8	682024000
Gerüstrohr 48,3mm 6,00m	21,6	682025000
Gerüstrohr 48,3mmm	3,6	682001000
Scaffold tube 48.3mm		

 verzinkt		
--	--	--

Gerüstrohranschluss Scaffold tube connection	0,27	584375000
 verzinkt Höhe: 7 cm		

Anschraubkupplung 48mm 50 Screw-on coupler 48mm 50	0,84	682002000
 verzinkt Schlüsselweite: 22 mm Einbauanleitung beachten!		

Framax-Betonierbühne U 1,25/2,70m Framax pouring platform U 1.25/2.70m	127,5	588377000
 Stahlteile verzinkt Holzteile gelb lasiert Lieferzustand: zusammengeklappt		

FF20-Adapter für Framax-Betonierbühne U FF20 adapter for Framax pouring platform U	6,8	588381000
 verzinkt Länge: 34 cm		

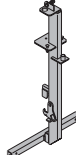
Top50-Adapter für Framax-Betonierbühne U Top50 adapter for Framax pouring platform U	18,5	588384000
 verzinkt Breite: 75 cm Höhe: 134 cm		

Geländersteher XP 1,20m Handrail post XP 1.20m	4,1	586460000
 verzinkt Höhe: 118 cm		

Fußwehrhalter XP 1,20m Toeboard holder XP 1.20m	0,64	586461000
 verzinkt Höhe: 21 cm		

	[kg]	Art.-Nr.
Geländerzwinge XP 40cm Railing clamp XP 40cm	7,7	586456000
 verzinkt Höhe: 73 cm		

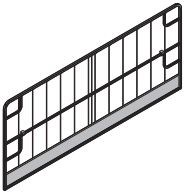
Schutzgitter XP 2,70x1,20m	22,2	586450000
Schutzgitter XP 2,50x1,20m	20,5	586451000
Schutzgitter XP 2,00x1,20m	17,4	586452000
Schutzgitter XP 1,20x1,20m	12,0	586453000
Protective grating XP		
 verzinkt		

Klettverschluss 30x380mm Velcro fastener 30x380mm	0,02	586470000
 gelb		

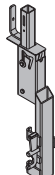
Trägerschalungsadapter XP Timber-beam formwork adapter XP	9,5	586476000
 verzinkt Höhe: 83,5 cm		

Schutzgeländerzwinge S Handrail clamp S	11,5	580470000
 verzinkt Höhe: 123 - 171 cm		

Schutzgeländerzwinge T Handrail clamp T	12,3	584381000
 verzinkt Höhe: 122 - 155 cm		

Schutzgeländer 1,10m Handrail post 1.10m	5,5	584384000
 verzinkt Höhe: 134 cm		

	[kg]	Art.-Nr.
Steckhülse 24mm Attachable sleeve 24mm	0,03	584385000
 grau Länge: 16,5 cm Durchmesser: 2,7 cm		

Schraubhülse 20,0 Screw sleeve 20.0	0,03	584386000
 gelb Länge: 20 cm Durchmesser: 3,1 cm		

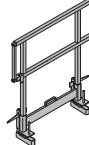
Seitenschutzgeländer T Side handrail clamping unit T	29,1	580488000
 verzinkt Länge: 115 - 175 cm Höhe: 112 cm		

Einschubgeländer T 1,80m Handrail post T 1.80m	17,7	584373000
 verzinkt		

Fußwehrhalter T 1,80m Toeboard holder T 1.80m	0,53	584392000
 verzinkt Höhe: 13,5 cm		

Doka-Vierstrangkette 3,20m Doka 4-part chain 3.20m	15,0	588620000
 Betriebsanleitung beachten!		CE

Anschlagkette 100cm 15kN Lifting chain 100cm 15kN	1,8	587548000
 Länge: 103 cm Betriebsanleitung beachten!		CE

Dokamatic-Umsetzgurt 13,00m Dokamatic lifting strap 13.00m	10,5	586231000
 grün Betriebsanleitung beachten!		CE

Kranöse Lifting bracket	6,2	580460000
 verzinkt Höhe: 59 cm		

[kg] Art.-Nr.

[kg] Art.-Nr.

Höhenjustierung WS10-WU16

10,1 **580206500**

Height adjuster WS10-WU16

verzinkt
Höhe: 45 cm

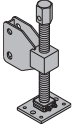

Anhängewinkel Typ A

0,96 **581641000**

Tie-off connector type A

verzinkt
Länge: 13,7 cm



Doka-Auffanggurt

3,6 **583022000**

Doka personal fall-arrest set

Betriebsanleitung beachten!

