

	[kg]	Art.-Nr.
Staxo 100-Rahmen 0,90m	24,0	582302000
Staxo 100-Rahmen 1,20m	28,0	582301000
Staxo 100-Rahmen 1,80m	37,0	582300000
Basic frame Staxo 100		

verzinkt

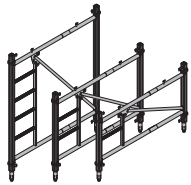

Diagonalkreuz 9.060	3,1	582322000
Diagonalkreuz 9.100	4,1	582772000
Diagonalkreuz 9.150	5,2	582773000
Diagonalkreuz 9.165	5,7	582627000
Diagonalkreuz 9.175	6,1	582334000
Diagonalkreuz 9.200	6,6	582774000
Diagonalkreuz 9.250	7,7	582775000
Diagonalkreuz 9.300	9,0	582323000
Diagonalkreuz 12.060	4,0	582324000
Diagonalkreuz 12.100	4,6	582610000
Diagonalkreuz 12.150	5,7	582612000
Diagonalkreuz 12.165	6,1	582628000
Diagonalkreuz 12.175	6,3	582335000
Diagonalkreuz 12.200	6,9	582614000
Diagonalkreuz 12.250	8,3	582616000
Diagonalkreuz 12.300	9,3	582325000
Diagonalkreuz 18.100	6,1	582620000
Diagonalkreuz 18.150	6,9	582622000
Diagonalkreuz 18.165	7,3	582629000
Diagonalkreuz 18.175	7,8	582336000
Diagonalkreuz 18.200	7,8	582624000
Diagonalkreuz 18.250	9,1	582626000
Diagonalkreuz 18.300	10,3	582326000
Diagonal cross		

verzinkt

Lieferzustand: zusammengelegt



Diagonalkreuz H 9.100	5,7	582337000
Diagonalkreuz H 9.150	7,2	582338000
Diagonalkreuz H 9.200	9,3	582339000
Diagonalkreuz H 9.250	11,3	582340000
Diagonalkreuz H 12.100	5,8	582341000
Diagonalkreuz H 12.150	7,5	582342000
Diagonalkreuz H 12.200	9,3	582343000
Diagonalkreuz H 12.250	10,5	582344000
Diagonal cross H		

verzinkt

Lieferzustand: zusammengelegt



Gabelkopf D U-head D	6,7	582709000
--------------------------------	-----	-----------

verzinkt

Länge: 20 cm

Breite: 22 cm

Höhe: 37 cm



Vierwegkopfspindel 4-way screw-jack head	10,4	582638000
--	------	-----------

verzinkt

Höhe: 86 cm



Kopfspindel Screw jack U-head	9,2	582636000
---	-----	-----------

verzinkt

Höhe: 74 cm



Lastspindel 70 oben Heavy-duty screw jack 70 top	9,2	582327000
--	-----	-----------

verzinkt

Höhe: 106 cm

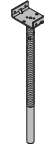

Spannmutter B Split nut B	2,0	582634000
-------------------------------------	-----	-----------

verzinkt



Klemmplatte D Clamping plate D	2,0	502709030
--	-----	-----------

verzinkt

Länge: 24 cm

Breite: 9 cm



Flügelmutter 15,0 Wing nut 15.0	0,31	581961000
---	------	-----------

verzinkt

Länge: 10 cm

Höhe: 5 cm

Schlüsselweite: 27 mm



DIN
18216

Quetschteil 15,0 330mm Locking rod 15.0	0,48	582641000
---	------	-----------

verzinkt

Schlüsselweite: 24 mm



Staxo-Spindelanschluss Dokamatic-Tisch Dokamatic table Staxo spindle connector	3,9	582347000
--	-----	-----------

verzinkt

Länge: 20,7 cm



Spindelkeil % Wedge for screw jack %	0,46	176071000
--	------	-----------

Länge: 20 cm

Breite: 16 cm



Staxo 100-Spindeladapter Staxo 100 spindle adapter	3,4	582351000
--	-----	-----------

verzinkt

Höhe: 26 cm



Superplatte 15,0 Super plate 15.0	1,1	581966000
---	-----	-----------

verzinkt

Höhe: 6 cm

Durchmesser: 12 cm

Schlüsselweite: 27 mm



DIN
18216

	[kg]	Art.-Nr.
Staxo-Keilaufleger WS10 Staxo wedge support WS10	8,7	582796000
 verzinkt Länge: 31 cm Breite: 15 cm Höhe: 23 cm		

Staxo-Keilaufleger WU12/14 Staxo wedge support WU12/14	12,2	582350000
 verzinkt Länge: 35,6 cm Breite: 15 cm Höhe: 33,6 cm		

Gelenkaufsatz Kopfspindel Swivel bearing plate for screw jack U-head	5,2	582799000
 verzinkt Länge: 20,8 cm Breite: 15,0 cm Höhe: 14,4 cm		

Fußspindel Screw jack foot	9,0	582637000
 verzinkt Höhe: 69 cm		

Lastspindel 70 Heavy-duty screw jack 70	8,8	582639000
 verzinkt Höhe: 101 cm		

Lastspindel 130 Heavy-duty screw jack 130	13,0	582711000
 verzinkt Höhe: 173 cm		

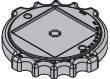
Ausgleichsplatte Compensating plate	1,2	582239000
 orange schwarz Durchmesser: 30 cm		

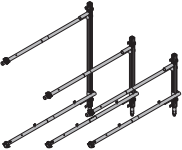
Staxo 100-Einzelstiel 0,90m	20,2	582305000
Staxo 100-Einzelstiel 1,20m	21,5	582304000
Staxo 100-Einzelstiel 1,80m	17,0	582303000
Staxo 100-single leg		
 verzinkt		

	[kg]	Art.-Nr.
Doka-Deckenstütze Eurex 60 550 Doka floor prop Eurex 60 550	47,0	582650000
 Alu Länge: 345 - 555 cm		

Verlängerung Eurex 60 2,00m Extension Eurex 60 2.00m	21,3	582651000
 blau pulverbeschichtet Alu Länge: 250 cm		

Kupplungsstück Eurex 60 Coupler Eurex 60	8,6	582652000
 Alu Länge: 100 cm Durchmesser: 12,8 cm		

Gabelkopf Eurex 60 U-head Eurex 60	2,9	582656000
 verzinkt Länge: 22 cm Breite: 20 cm Höhe: 12 cm		

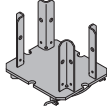
Vierwegkopf Eurex 60 4-way head Eurex 60	4,5	582655000
 verzinkt Länge: 25 cm Breite: 21 cm Höhe: 21 cm		

Justierstütze Eurex 60 550 Plumbing strut Eurex 60 550	42,5	582658000
 blau pulverbeschichtet Alu Länge: 343 - 553 cm		

Stützenkopf Eurex 60 Top50 Prop head Eurex 60 Top50	7,1	582665000
 verzinkt Höhe: 50 cm		

	[kg]	Art.-Nr.
Verbindungsstück Eurex 60 IB Connector Eurex 60 IB	4,2	582657500
 verzinkt Länge: 15 cm Breite: 15 cm Höhe: 30 cm		

Justierstützenfuß Eurex 60 EB Plumbing strut shoe Eurex 60 EB	8,0	582660500
 verzinkt Länge: 31 cm Breite: 12 cm Höhe: 33 cm		

Drehkupplung 48mm Eurex 60 Swivel coupler 48mm Eurex 60	1,0	582654000
 verzinkt Schlüsselweite: 22 mm Einbauanleitung beachten!		

Justierstütze 340 IB Plumbing strut 340 IB	16,7	588696000
 verzinkt Länge: 190,8 - 341,8 cm		

Justierstütze 340 IB EF Plumbing strut 340 IB EF	14,9	588247500
 verzinkt Länge: 190,8 - 341,8 cm		

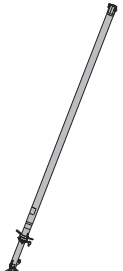
Justierstütze 540 IB Plumbing strut 540 IB	30,7	588697000
 verzinkt Länge: 310,5 - 549,2 cm		

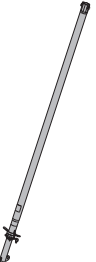
Justierstütze 540 IB EF Plumbing strut 540 IB EF	28,9	588250500
 verzinkt Länge: 310,5 - 549,2 cm		

	[kg]	Art.-Nr.
Strebenschuh EB Strut shoe EB	0,93	588946000
 verzinkt Breite: 8 cm Höhe: 13 cm		

Stützenschuh EB Prop shoe EB	1,8	588245500
 verzinkt Länge: 20 cm Breite: 11 cm Höhe: 10 cm		

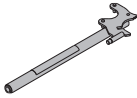
Universal-Lösewerkzeug Universal dismantling tool	3,7	582768000
 verzinkt Länge: 75,5 cm		

Stützbein 1,20m Removable folding tripod 1.20m	20,7	586145000
 verzinkt Höhe: 120 cm Lieferzustand: zusammengeklappt		

Doka-Expressanker 16x125mm Doka express anchor 16x125mm	0,31	588631000
 verzinkt Länge: 18 cm Einbauanleitung beachten!		

Doka-Coil 16mm Doka coil 16mm	0,009	588633000
 verzinkt Durchmesser: 1,6 cm		

Lehre Doka-Expressanker 16x125mm Gauge for Doka express anchor 16x125mm	0,03	588632000
 schwarz Länge: 3 cm Durchmesser: 2 cm		

Gerüstbelag 60/60cm	6,1	582330500
Gerüstbelag 60/100cm	9,5	582306500
Gerüstbelag 60/150cm	13,6	582307500
Gerüstbelag 60/175cm	15,5	582332500
Gerüstbelag 60/200cm	17,8	582308500
Gerüstbelag 60/250cm	22,2	582309500
Gerüstbelag 60/300cm	26,2	582310500

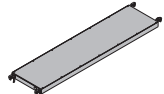
Scaffold planking		
 Alu		

Gerüstbelag 60/100cm mit Durchstieg	9,5	582311500
Gerüstbelag 60/150cm mit Durchstieg	13,8	582312500
Gerüstbelag 60/175cm mit Durchstieg	15,5	582333500
Gerüstbelag 60/200cm mit Durchstieg	17,7	582313500
Gerüstbelag 60/250cm mit Durchstieg	20,8	582314500
Gerüstbelag 60/300cm mit Durchstieg	26,3	582315500

Scaffold planking with manhole		
 Alu		

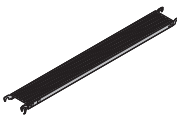
	[kg]	Art.-Nr.
Gerüstbelag 30/100cm	7,4	582231000
Gerüstbelag 30/150cm	10,6	582232000
Gerüstbelag 30/200cm	13,5	582234000
Gerüstbelag 30/250cm	16,4	582235000
Gerüstbelag 30/300cm	19,5	582236000
Scaffold planking		
	verzinkt	

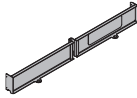
Staxo 100-Fußwehr	5,5	582329000
Staxo 100 toeboard		
	verzinkt	
Länge: 131 cm		
Höhe: 15 cm		

Staxo 100-Belagstrebe 1,00m	6,1	582348000
Staxo 100-Belagstrebe 1,50m	9,0	582349000
Staxo 100 planking strut		
	verzinkt	
Schlüsselweite: 22 mm		

Staxo-Stirngeländer	10,5	582316000
Staxo front railing		
	verzinkt	
Länge: 140 cm		
Höhe: 152 cm		

Staxo-Seitengeländer 100	17,5	582317500
Staxo-Seitengeländer 150	20,0	582318500
Staxo-Seitengeländer 175	23,2	582331500
Staxo-Seitengeländer 200	24,1	582319500
Staxo-Seitengeländer 250	27,5	582320500
Staxo-Seitengeländer 300	31,1	582321500
Staxo side railing		
	verzinkt	
Höhe: 152 cm		

Federbolzen 16mm	0,25	582528000
Spring locked connecting pin 16mm		
	verzinkt	
Länge: 15 cm		

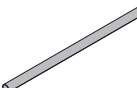
Gerüstrohr 48,3mm 0,50m	1,7	682026000
Gerüstrohr 48,3mm 1,00m	3,6	682014000
Gerüstrohr 48,3mm 1,50m	5,4	682015000
Gerüstrohr 48,3mm 2,00m	7,2	682016000
Gerüstrohr 48,3mm 2,50m	9,0	682017000
Gerüstrohr 48,3mm 3,00m	10,8	682018000
Gerüstrohr 48,3mm 3,50m	12,6	682019000
Gerüstrohr 48,3mm 4,00m	14,4	682021000
Gerüstrohr 48,3mm 4,50m	16,2	682022000
Gerüstrohr 48,3mm 5,00m	18,0	682023000
Gerüstrohr 48,3mm 5,50m	19,8	682024000
Gerüstrohr 48,3mm 6,00m	21,6	682025000
Gerüstrohr 48,3mmm	3,6	682001000
Scaffold tube 48.3mm		
	verzinkt	

	[kg]	Art.-Nr.
Übergangsdrehkupplung 48/76mm	1,9	582563000
Transition swivel coupler 48/76mm		
	verzinkt	
Schlüsselweite: 22 mm		
Einbauanleitung beachten!		

Drehkupplung 48mm	1,5	582560000
Swivel coupler 48mm		
	verzinkt	
Schlüsselweite: 22 mm		
Einbauanleitung beachten!		

Normalkupplung 48mm	1,2	682004000
Normal coupler 48mm		
	verzinkt	
Schlüsselweite: 22 mm		
Einbauanleitung beachten!		

Ankerschuh für Treppenturm	3,4	582680000
Anchoring shoe for stair tower		
	verzinkt	
Länge: 22 cm		
Breite: 12 cm		
Höhe: 22 cm		

Konusschraube B 7cm	0,86	581444000
Cone screw B 7cm		
	rot	
Länge: 10 cm		
Durchmesser: 7 cm		
Schlüsselweite: 50 mm		

Spannbügel 8	2,7	582751000
Brace stirrup 8		
	verzinkt	
Breite: 19 cm		
Höhe: 46 cm		
Schlüsselweite: 30 mm		

Sparrenpfettenanker rechts	0,09	582521000
Sparrenpfettenanker links	0,09	582522000
Rafter plate		
	verzinkt	
Länge: 17 cm		

Geländer 1,50m	12,4	582754000
Handrail post 1.50m		
	verzinkt	

Schutzgeländerzwing S	11,5	580470000
Handrail clamp S		
	verzinkt	
Höhe: 123 - 171 cm		

	[kg]	Art.-Nr.
Einschubgeländer T 1,80m Handrail post T 1.80m	17,7	584373000
 verzinkt		

Fußwehrhalter T 1,80m Toeboard holder T 1.80m	0,53	584392000
 verzinkt Höhe: 13,5 cm		

Gerüstrohranschluss Scaffold tube connection	0,27	584375000
 verzinkt Höhe: 7 cm		

Staxo 100-Montagegalgen 40kg Staxo 100 mounting gallows 40kg	7,5	582328000
 verzinkt Höhe: 258 cm Betriebsanleitung beachten!		CE

Staxo 100-Aufzugsseil 40kg 30m Staxo 100 hoisting cable 40kg 30m	1,3	582346000
		

Staxo 100-Anschlagseil 40cm Staxo 100 attaching cable 40cm	0,31	582345000
 CE		

Abspannung für Traggerüste Bracing for load-bearing towers	11,6	582795000
 verzinkt blau lackiert		

Abspann-Riegelverbinder WS10 Bracing waling connector WS10	2,7	582756000
 verzinkt Länge: 46,7 cm		

Spindellasche T Spindle connecting plate T	3,1	584371000
 verzinkt Breite: 20 cm Höhe: 25 cm		

	[kg]	Art.-Nr.
Verbindungsbolzen 10cm Connecting pin 10cm	0,34	580201000
 verzinkt Länge: 14 cm		

Federvorstecker 5mm Spring cotter 5mm	0,05	580204000
 verzinkt Länge: 13 cm		

Umsetzstab 15,0 Lifting rod 15.0	1,9	586074000
 blau Höhe: 57 cm Betriebsanleitung beachten!		CE

Jochplatte 15,0 Retaining plate 15.0	1,8	586073000
 verzinkt Länge: 17 cm Breite: 12 cm Höhe: 11 cm		

Kombi-Ankerstopfen R20/25 Universal plug R20/25	0,003	588180000
 blau Durchmesser: 3 cm		

Zahnstangenwinde 70 Winch 70	31,0	582779000
 blau lackiert Höhe: 126 cm Betriebsanleitung beachten!		CE

Zahnstangenwinde 125 Winch 125	63,8	582780000
 blau lackiert Höhe: 189 cm Betriebsanleitung beachten!		CE

Staxo/d2-Adapter Staxo/d2 adapter frame	14,1	582781000
 blau lackiert Länge: 37 cm Breite: 36 cm Höhe: 36 cm		

Vollelastikrad Solid tire wheel	34,5	582573000
 blau lackiert Höhe: 45 cm		

Schwerlastrad 15kN Heavy-duty wheel 15kN	33,0	582575000
 blau lackiert Höhe: 41 cm		

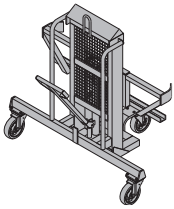
Zweirad-Transportroller
Double wheeled transporter[kg] Art.-Nr.
5,0 **582558000**blau lackiert
Breite: 57 cm**Hubwagen TG**
Shifting carriage TG168,0 **582778000**verzinkt
Länge: 99 cm
Breite: 152 cm
Höhe: 148 cm
Betriebsanleitung beachten!

CE

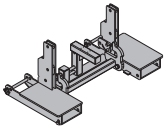
Umsetzgerät TG für Stapler
Fork lift shifting device TG83,0 **582797000**verzinkt
Länge: 60 cm
Breite: 113 cm
Höhe: 52 cm
Betriebsanleitung beachten!

CE

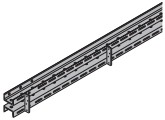
Mehrzweckriegel WS10 Top50 2,00m
Multi-purpose waling WS10 Top50 2.00m38,9 **580007000**

blau lackiert

Doka-Auffanggurt
Doka personal fall-arrest set3,6 **583022000**

Betriebsanleitung beachten!

CE