







	[kg]	Art.-Nr.
Doka-Faltbühne K 3,00m	291,5	580442000
Doka-Faltbühne K 4,50m	444,5	580443000
Doka folding platform K		
		
Holzteile gelb lasiert		
Stahlteile verzinkt		
Lieferzustand: zusammengeklappt		

Faltkonsole K	52,4	580441000
Folding bracket K		
		
verzinkt		
Länge: 224 cm		
Höhe: 245 cm		
Lieferzustand: zusammengeklappt		

Anschlusschuh K	6,4	580451000
Connection-shoe K		
		
verzinkt		
Länge: 25 cm		
Breite: 17 cm		

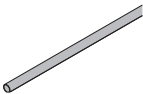
Hängebühne 120 3,30m	44,0	580411000
Hängebühne 120 4,30m	52,6	580412000
Suspended platform 120		
		
verzinkt		
Lieferzustand: zusammengelegt		

Gerüstrohr 48,3mm 0,50m	1,7	682026000
Gerüstrohr 48,3mm 1,00m	3,6	682014000
Gerüstrohr 48,3mm 1,50m	5,4	682015000
Gerüstrohr 48,3mm 2,00m	7,2	682016000
Gerüstrohr 48,3mm 2,50m	9,0	682017000
Gerüstrohr 48,3mm 3,00m	10,8	682018000
Gerüstrohr 48,3mm 3,50m	12,6	682019000
Gerüstrohr 48,3mm 4,00m	14,4	682021000
Gerüstrohr 48,3mm 4,50m	16,2	682022000
Gerüstrohr 48,3mm 5,00m	18,0	682023000
Gerüstrohr 48,3mm 5,50m	19,8	682024000
Gerüstrohr 48,3mm 6,00m	21,6	682025000
Gerüstrohr 48,3mmm	3,6	682001000
Scaffold tube 48.3mm		
		
verzinkt		

Anschraubkupplung 48mm 50	0,84	682002000
Screw-on coupler 48mm 50		
		
verzinkt		
Schlüsselweite: 22 mm		
Einbauanleitung beachten!		

Drehkupplung 48mm	1,5	582560000
Swivel coupler 48mm		
		
verzinkt		
Schlüsselweite: 22 mm		
Einbauanleitung beachten!		

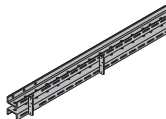
	[kg]	Art.-Nr.
Mehrweckriegel WS10 Top50 3,00m	58,9	580011000
Mehrweckriegel WS10 Top50 3,50m	68,4	580012000
Mehrweckriegel WS10 Top50 4,00m	79,4	580013000
Multi-purpose waling WS10 Top50		
		
blau lackiert		

Höhenjustierspindel M36	6,2	500663002
Adjusting spindle M36		
		
verzinkt		
Länge: 31 cm		
Höhe: 29,2 cm		

Verbindungsbolzen 10cm	0,34	580201000
Connecting pin 10cm		
		
verzinkt		
Länge: 14 cm		

Federvorstecker 5mm	0,05	580204000
Spring cotter 5mm		
		
verzinkt		
Länge: 13 cm		

Riegelhalter 9-15cm	2,7	580625000
Waling-to-bracket holder 9-15cm		
		
verzinkt		

Keilriegelhalter	2,5	580526000
Waling-to-bracket holder		
		
verzinkt		
Länge: 26 cm		
Höhe: 31 cm		

Framax-Spannklemme	1,5	588152000
Framax wedge clamp		
		
verzinkt		
Länge: 21 cm		

Elementstütze 340 IB	24,3	580365000
Panel strut 340 IB		
bestehend aus:		
(A) Justierstütze 340 IB	16,7	588696000
verzinkt		
Länge: 190,8 - 341,8 cm		
(B) Justierstrebe 120 IB	7,6	588248500
verzinkt		
Länge: 81,5 - 130,6 cm		

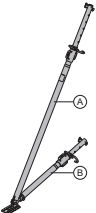
		
verzinkt		
Lieferzustand: zusammengeklappt		

Stützenkopf EB	3,1	588244500
Prop head EB		
		
verzinkt		
Länge: 40,8 cm		
Breite: 11,8 cm		
Höhe: 17,6 cm		

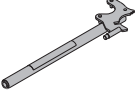
	[kg]	Art.-Nr.
Universal-Lösewerkzeug Universal dismantling tool	3,7	582768000
	verzinkt Länge: 75,5 cm	

Sternschraube Star screw	0,75	580425000
	verzinkt Länge: 17 cm	

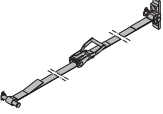
Windabspannung MF/150F/K 6,00m Wind bracing MF/150F/K 6.00m	4,7	580665000
	verzinkt	

Steckbolzen D16/112 Pin D16/112	0,29	500403330
	verzinkt Länge: 16 cm	

Betonierkonsole L Top scaffold bracket L	12,6	587153500
	verzinkt Länge: 101 cm Höhe: 159 cm	

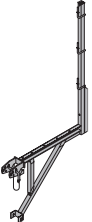
Universal-Konsole 90 Universal bracket 90	30,4	580476000
	verzinkt Länge: 121 cm Höhe: 235 cm	

Framax-Konsole 90 Framax bracket 90	12,5	588167000
	verzinkt Breite: 103 cm Höhe: 185 cm Lieferzustand: Geländer beige- legt	

Geländerzwinge XP 40cm Railing clamp XP 40cm	7,7	586456000
	verzinkt Höhe: 73 cm	

	[kg]	Art.-Nr.
Geländersteher XP 1,20m Handrail post XP 1.20m	4,1	586460000
	verzinkt Höhe: 118 cm	

Fußwehrhalter XP 1,20m Toeboard holder XP 1.20m	0,64	586461000
	verzinkt Höhe: 21 cm	

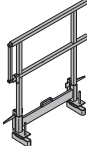
Seitenschutzgeländer T Side handrail clamping unit T	29,1	580488000
	verzinkt Länge: 115 - 175 cm Höhe: 112 cm	

Schutzgeländerzwinge S Handrail clamp S	11,5	580470000
	verzinkt Höhe: 123 - 171 cm	

Universal-Geländerbügel Universal railing shackle	3,0	580478000
	verzinkt Höhe: 20 cm	

Gerüstrohranschluss Scaffold tube connection	0,27	584375000
	verzinkt Höhe: 7 cm	

Doka-Vierstrangkette 3,20m Doka 4-part chain 3.20m	15,0	588620000
	Betriebsanleitung beachten!	CE

Umsetzbalken 110kN 6,00m Lifting beam 110kN 6.00m	136,5	586359000
	verzinkt Länge: 626 cm Betriebsanleitung beachten!	CE

Bühnendurchstieg B 70/60cm Manhole B 70/60cm	22,0	581530000
	Stahlteile verzinkt Holzteile gelb lasiert Länge: 81 cm Breite: 71 cm	

Verbotsschild "Zutritt Verboten" 300x300mm 0,70 **581575000**
Warning sign "No entry" 300x300mm



Doka-Auffanggurt 3,6 **583022000**
Doka personal fall-arrest set

Betriebsanleitung beachten!



Universal-Werkzeugbox 15,0 9,1 **580392000**
Universal tool box 15.0

Im Lieferumfang enthalten:

(A) **Umschaltknarre 1/2"** 0,73 **580580000**
verzinkt
Länge: 30 cm

(B) **Gabelschlüssel 13/17** 0,08 **580577000**

(C) **Gabelschlüssel 22/24** 0,22 **580587000**

(D) **Gabelschlüssel 30/32** 0,80 **580897000**

(E) **Gabelschlüssel 36/41** 1,0 **580586000**

(F) **Ringschlüssel 17/19** 0,27 **580590000**

(G) **Vierkantnuss 22** 0,31 **580589000**

(H) **Steckschlüssel 41** 0,99 **580585000**

(I) **Verlängerung 11cm 1/2"** 0,20 **580581000**

(J) **Verlängerung 22cm 1/2"** 0,31 **580582000**

(K) **Kardangeln 1/2"** 0,16 **580583000**

(L) **Stecknuss 19 1/2" L** 0,16 **580598000**

(M) **Stecknuss 13 1/2"** 0,06 **580576000**

(N) **Stecknuss 24 1/2"** 0,12 **580584000**

(O) **Stecknuss 30 1/2"** 0,20 **580575000**

(P) **Vorlaufschlüssel 15,0 DK** 0,30 **580579000**
verzinkt
Länge: 8 cm
Schlüsselweite: 30 mm

