



Formwork & Scaffolding.  
We make it work.

# Timber formwork beams

Doka beams XT20 | H20 top | H20 pro | H20 eco

## User Information

Instructions for assembly and use (Method statement)





## Contents

4	Elementary safety warnings
7	Intended use
8	Possible incorrect usages
9	Technical condition
13	General
14	Transporting, stacking and storing
16	Doka beam XT20
17	Doka beam H20 top
18	Doka beam H20 pro
19	Doka beam H20 eco
20	Deflection diagram

<b>22</b>	<b>Article list</b>
-----------	---------------------

## Elementary safety warnings

### User target groups

- This booklet is aimed at all persons who will be working with the Doka product or system that it describes. It contains information on the standard design for setting up this system, and on correct, compliant utilisation of the system.
- All persons working with the product described herein must be familiar with the contents of this booklet and with all the safety instructions it contains.
- Persons who are incapable of reading and understanding this booklet, or who can do so only with difficulty, must be instructed and trained by the customer.
- The customer is to ensure that the information materials provided by Doka (e.g. User Information booklets, Instructions for Assembly and Use, Operating Instruction manuals, plans etc.) are up to date and available to all users, and that they have been made aware of them and have easy access to them at the usage location.
- In the relevant technical documentation and formwork utilisation plans, Doka shows the workplace safety precautions that are necessary in order to use the Doka products safely in the usage situations shown.  
In all cases, users are obliged to ensure compliance with national laws, standards and regulations throughout the entire project and to take appropriate additional or alternative workplace safety precautions where necessary.

### Hazard assessment

- The customer is responsible for drawing up, documenting, implementing and continually updating a hazard assessment at every job-site. This booklet serves as the basis for the site-specific hazard assessment, and for the instructions given to users on how to prepare and utilise the system. It does not substitute for these, however.

### Remarks on this booklet

- This document can be used as general Instructions for Assembly and Use (Method Statement) or be incorporated into site-specific Instructions for Assembly and Use (Method Statement).
- **The graphics, animations and videos in this document or app sometimes depict partially assembled assemblies and may require additional safety equipment and/or measures to comply with safety regulations.**  
The customer must ensure all applicable regulations are complied with, even if they are not shown or implied in the graphics, animations and videos provided.
- **Individual sections contain further safety instructions and/or special warnings as applicable.**

### Planning

- Provide safe workplaces for those using the formwork (e.g. for when it is being erected/dismantled, modified or repositioned etc). It must be possible to get to and from these workplaces via safe access routes!
- **If you are considering any deviation from the details and instructions given in this booklet, or any application which goes beyond those described in the booklet, then revised static calculations must be produced for checking, as well as supplementary assembly instructions.**

### Regulations; industrial safety

- All laws, Standards, industrial safety regulations and other safety rules applying to the utilisation of our products in the country and/or region in which you are operating must be observed at all times.
- If a person or object falls against, or into, the side-guard component and/or any of its accessories, the component affected may only continue in use after it has been inspected and passed by an expert.

## Rules applying during all phases of the assignment

- The customer must ensure that this product is erected and dismantled, reset and generally used for its intended purpose in accordance with the applicable laws, standards and rules, under the direction and supervision of suitably skilled persons. These persons' mental and physical capacity must not in any way be impaired by alcohol, medicines or drugs.
- Doka products are technical working appliances which are intended for industrial / commercial use only, always in accordance with the respective Doka User Information booklets or other technical documentation authored by Doka.
- The stability and load-bearing capacity of all components and units must be ensured during all phases of the construction work!
- Do not step on or apply strain to cantilevers, closures, etc. until suitable measures to ensure their stability have been correctly implemented (e.g. by tie-backs).
- Strict attention to and compliance with the functional instructions, safety instructions and load specifications are required. Non-compliance can cause accidents and severe injury (risk of fatality) and considerable damage to property.
- Sources of fire in the vicinity of the formwork are prohibited. Heaters are permissible only when used correctly and situated a correspondingly safe distance from the formwork.
- Customer must give due consideration to any and all effects of the weather on the equipment and regards both its use and storage (e.g. slippery surfaces, risk of slipping, effects of the wind, etc.) and implement appropriate precautionary measures to secure the equipment and surrounding areas and to protect workers.
- All connections must be checked at regular intervals to ensure that they are secure and in full working order.  
In particular threaded connections and wedged connections have to be checked and retightened as necessary in accordance with activity on the jobsite and especially after out-of-the-ordinary occurrences (e.g. after a storm).
- It is strictly forbidden to weld Doka products – in particular anchoring/tying components, suspension components, connector components and castings etc. – or otherwise subject them to heating.  
Welding causes serious change in the microstructure of the materials from which these components are made. This leads to a dramatic drop in the failure load, representing a very great risk to safety.  
It is permissible to cut individual tie rods to length with metal cutting discs (introduction of heat at the end of the rod only), but it is important to ensure that flying sparks do not heat and thus damage other tie rods.  
The only articles which are allowed to be welded are those for which the Doka literature expressly points out that welding is permitted.

## Assembly

- The equipment/system must be inspected by the customer before use, to ensure that it is in an acceptable condition. Steps must be taken to exclude components that are damaged, deformed, or weakened due to wear, corrosion or rot (e.g. fungal decay).
- Using our safety and formwork systems together with those of other manufacturers can create risks that may lead to injury and damage to property. This requires separate verification by the user.
- The equipment/system must be assembled and erected in accordance with the applicable laws, standards and rules by trained customer personnel whilst maintaining any applicable safety inspections that may be required.
- It is not permitted to modify Doka products; such modifications constitute a safety risk.

## Closing the formwork

- Doka products and systems must be set up so that all loads acting upon them are safely transferred!

## Pouring

- Do not exceed the permitted fresh-concrete pressures. Over-high pouring rates overload the formwork, cause greater deflection and risk breakage.

## Stripping the formwork

- Do not strip out the formwork until the concrete has reached sufficient strength and the person in charge has given the order for the formwork to be stripped out!
- When stripping out the formwork, never use the crane to break concrete cohesion. Use suitable tools such as timber wedges, special pry-bars or system features such as Framax stripping corners.
- When stripping out the formwork, do not endanger the stability of any part of the structure, or of any scaffolding, platforms or formwork that is still in place!

## Transporting, stacking and storing

- Observe all country-specific regulations applying to the handling of formwork and scaffolding. For system formwork the Doka slinging means stated in this booklet must be used – this is a mandatory requirement.  
If the type of sling is not specified in this document, the customer must use slinging means that are suitable for the application envisaged and that comply with the regulations.
- When lifting, always make sure that the unit to be lifted and its individual parts can absorb the forces that occur.
- Remove loose parts or secure them so that they cannot slip out of position and drop.
- When lifting formwork or formwork accessories with a crane, no persons must be carried along, e.g. on working platforms or in multi-trip packaging.
- All components must be stored safely, following all the special Doka instructions given in the relevant sections of this document!

## Maintenance

- Only original Doka components may be used as spare parts. Repairs may only be carried out by the manufacturer or authorised facilities.

## Miscellaneous

The weights as stated are averages for new material; actual weights can differ, depending on material tolerances. Dirt accretions, moisture saturation, etc. can also affect weight.

We reserve the right to make alterations in the interests of technical progress.

## Symbols used

The following symbols are used in this document:



### DANGER

This is a notifier drawing attention to an extremely dangerous situation in which non-compliance with this notifier will lead to death or severe, irreversible injury.



### WARNING

This is a notifier drawing attention to a dangerous situation in which non-compliance with this notifier can lead to death or severe, irreversible injury.



### CAUTION

This is a notifier drawing attention to a dangerous situation in which non-compliance with this notifier can lead to slight, reversible injury.



### NOTICE

This is a notifier drawing attention to a situation in which non-compliance with this notifier can lead to malfunctions or damage to property.



### Instruction

Indicates that actions have to be performed by the user.



### Sight-check

Indicates that you need to do a sight-check to make sure that necessary actions have been carried out.



### Tip

Points out useful practical tips.



### Reference

Cross-references other documents.

## Intended use

Doka timber formwork beams are formwork beams made of wood and intended for use in floor and wall formwork.

Timber formwork beams are approved only for loads imposed by direct support for formwork in concrete construction, but not for heavy point loads in conjunction with wide spans (e.g. holding girders).

### Practical example

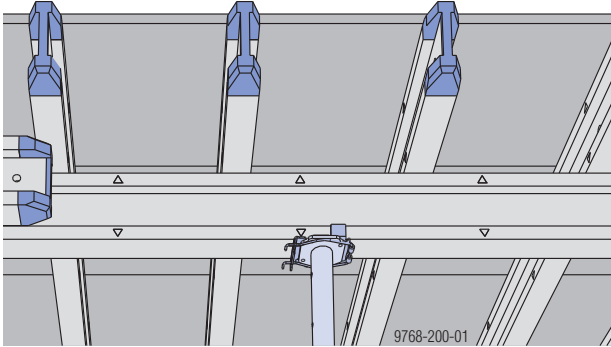

Information on use as intended by the manufacturer is also to be found in the User Information booklets for the Doka formwork systems (e.g. Dokaflex, Dokamatic table, Large-area formwork Top 50).

# Possible incorrect usages

**WARNING**

► Use Doka formwork beams only in the 'upright' position.

The only exceptions to this rule are use cases explicitly permitted in Doka documents. (e. g. in formwork for casting drop beams with the Beam forming support 20, etc.)

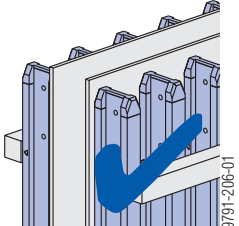
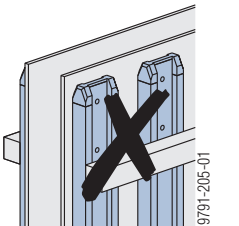
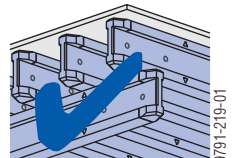
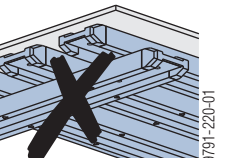
Correct 'upright' use (load direction parallel to web plane).	Incorrect 'turned flat' use (load direction transverse to web plane).
<p>Wall formwork</p>  <p>9791-206-01</p>	 <p>9791-206-01</p>
<p>Slab formwork</p>  <p>9791-219-01</p>	 <p>9791-220-01</p>

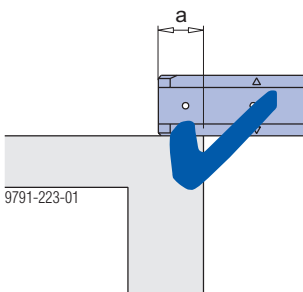
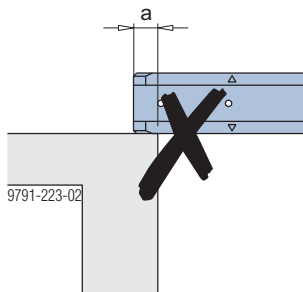
Supported length <i>a</i> of the beam ≥ 15 cm permitted.	Supported length <i>a</i> of the beam < 15 cm not permitted.
 <p>9791-223-01</p>	 <p>9791-223-02</p>

**WARNING**

► The uses illustrated below are prohibited, as are other, similar uses!

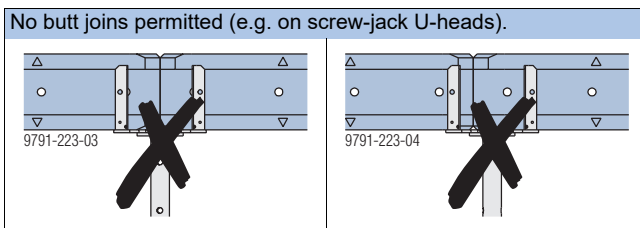
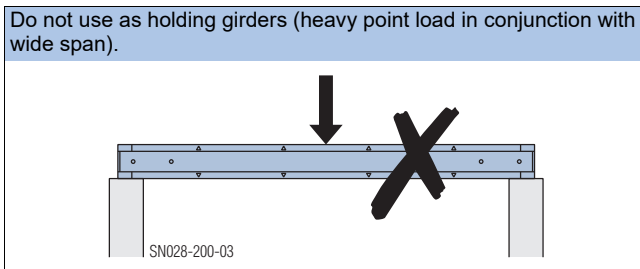
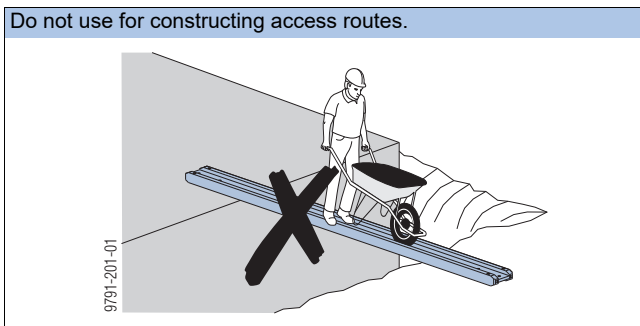
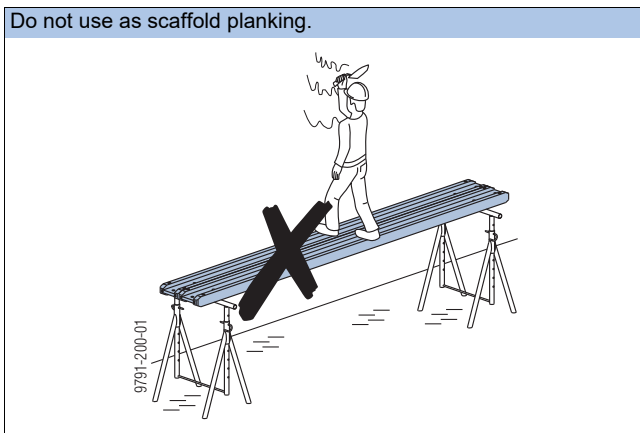



## Technical condition

The following quality criteria define the statically permitted degree of damage or weakening.

Use is prohibited if the damage is more extensive.

### Flange

#### Angled cracks (across the grain)

- not permissible

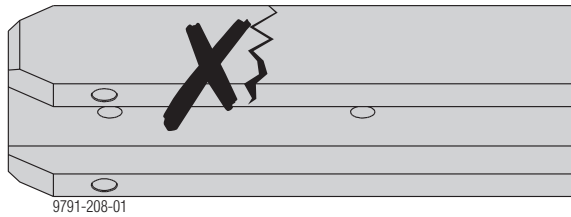

#### Straight cracks (parallel to the flange)

- parallel to the flange up to width **a = 2 mm** permissible.
- It must be impossible to pull the flange apart.

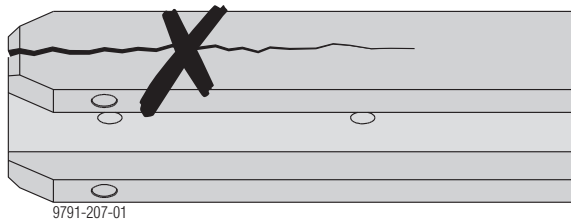
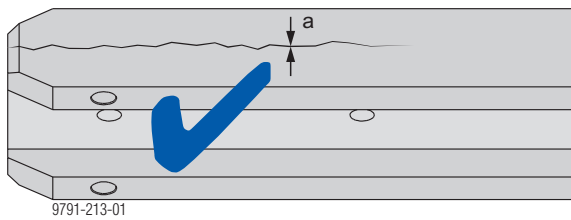

### Splintering at side

- permissible up to depth **a = 10 mm** and length **b** of **500 mm** on one side.

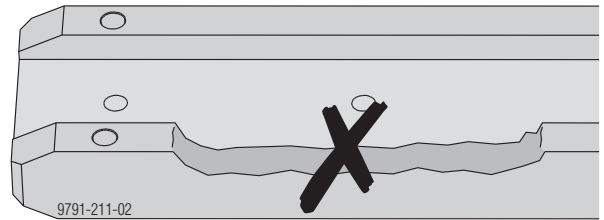
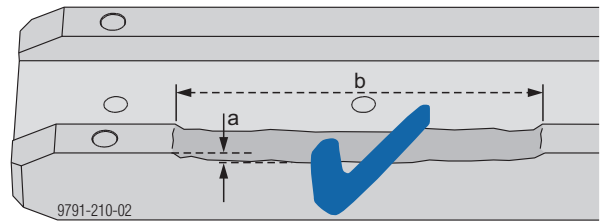

### Angled splintering across the edge

- permissible up to **a = 30 mm** across the diagonal and up to a length **b** of **500 mm**.

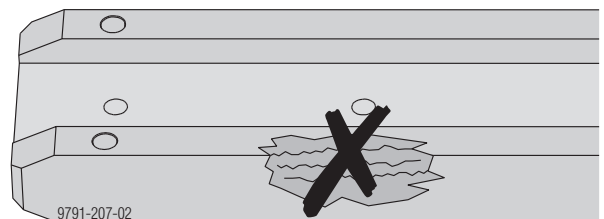
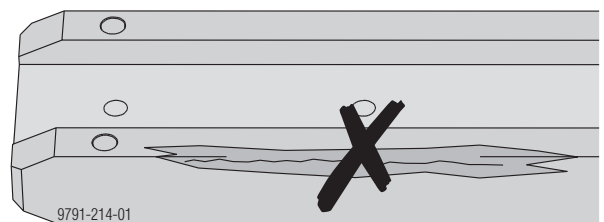
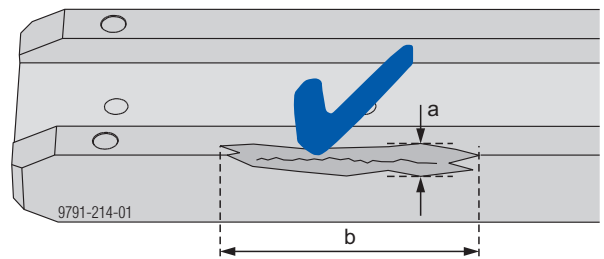

## Saw cuts

- Superficial saw cuts up to depth **a = 2 mm** are permissible.

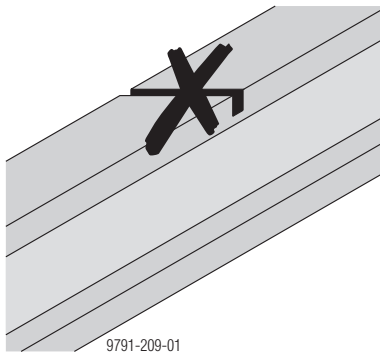
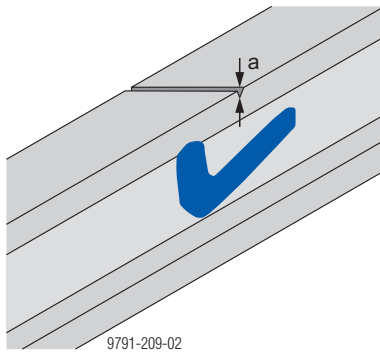

## Drilled holes in flange

- Not permissible, with the exception of system holes:

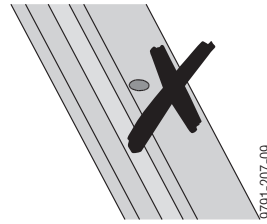

- Waling attachment with beam screw

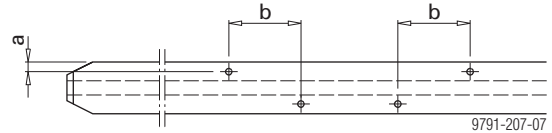

a ... 15 mm  
b ... 112 mm  
Drilled-hole diameter max. 10 mm

- Attachment of table head with beam screw

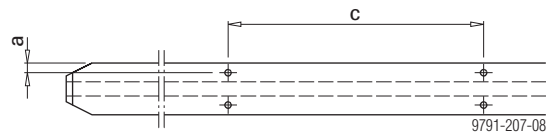

a ... 15 mm  
c ... 396 mm  
Drilled-hole diameter max. 10 mm

## Flange end

- Splintering **a** up to length **60 mm** is permissible.

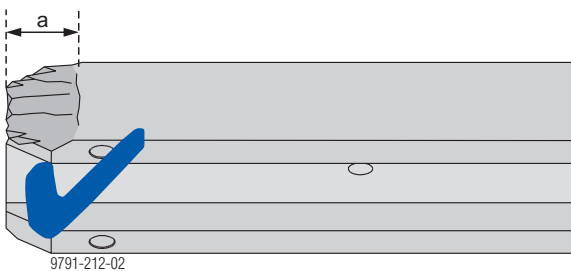
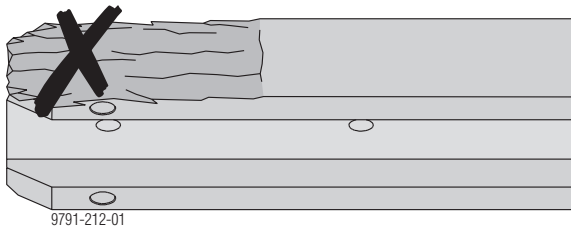

- Attachment of profiled timber formers

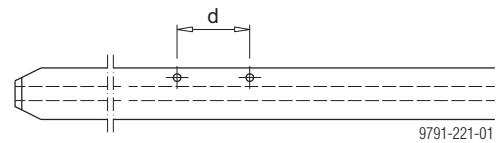

d ... 113 mm  
Drilled-hole diameter max. 12 mm

- System holes in the plastic cap of the Doka beam top

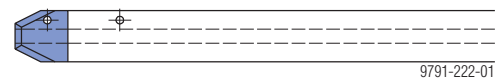

Drilled-hole diameter max. 10 mm

- Damage to the plastic cap has no effect on load-bearing capacity, but beams evincing damage of this kind do not necessarily meet the quality criteria for Doka rental formwork.

## Web

### Damage to web

- Permissible only when slight and on one side of the beam.

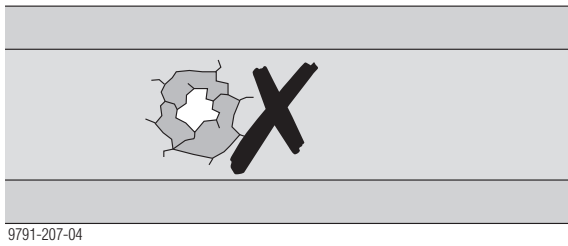
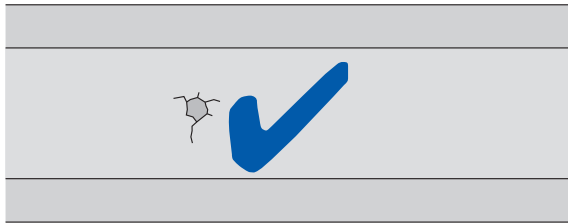

### Damage to web end

- permissible up to max.  $a = 20$  mm

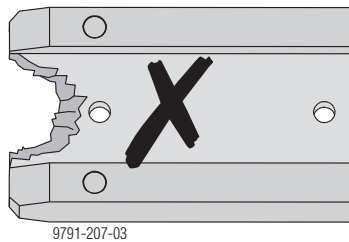
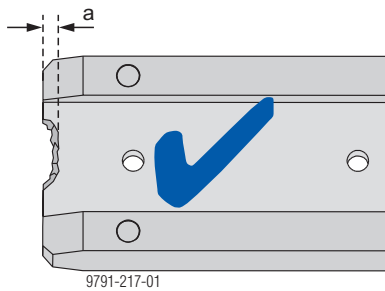

### Drilled holes in web

Permissible drilled holes:

- Standard holes
  - 2 holes dia. 21.5 mm in each standard beam
- Additional system holes for:
  - Flange claw
  - Fastening plate
  - Beam connection splice plate
  - Table head 30
  - Lifting bracket
  - Portal head

In addition to the system holes, one hole up to dia. 20 mm per linear metre is permissible.

If numerous holes have been drilled, the overall condition of the beam is the decisive criterion.

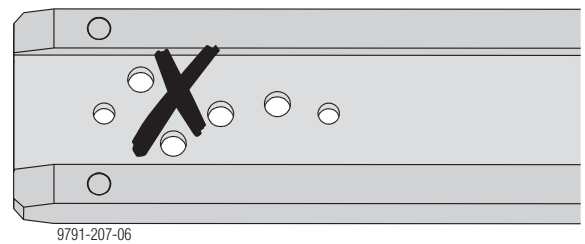
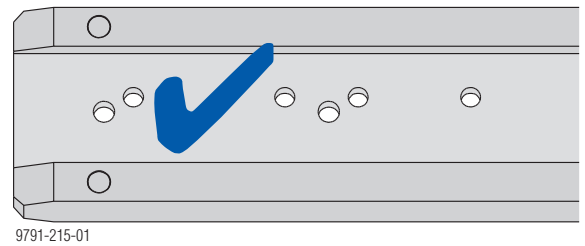

## Flange/web

### Detachment of flange from web

- not permissible

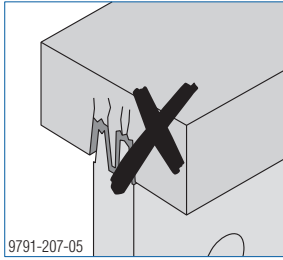

## Fungal attack

### Mould/blueing

Appearance:

- Black spots
- White filaments
- Blue to black discolouration

Wood discolouration caused by mould/blueing has no effect on the load-bearing capacity of the beam.



#### **WARNING**

- ▶ Mould/blueing can occur in combination with wood-degrading fungi (timber-decay fungi, dry rot).

### Timber-decay fungi

Timber-decay fungi reduce the beam's load-bearing capacity.



#### **WARNING**

- ▶ Scrap beams weakened by timber-decay fungi!

They can be identified by their reduced compressive strength compared to sound sections, for example by compression-testing with a plain, slot-screw screwdriver.

## General

### Note:

To achieve maximum service life, follow the storage instructions (see the section headed 'Transporting, stacking and storing'). Prudent handling is also important, particularly when stripping out slabs.



To prevent any staining of the concrete from direct contact with new formwork beams, we recommend covering the formwork beams with a non-woven fabric.

## Reprocessing scrap material

---

Doka formwork beams contain no wood preservatives and, consequently, they can be deposited for reprocessing.

Reprocessing by incineration in suitable incineration plants is recommended. It is advisable not to attempt to burn scrap material in open fires or domestic wood-burners.

Always comply with the applicable local or national regulations.

# Transporting, stacking and storing

## Transport

- Always use slings for lifting beam stacks - do not use chains.

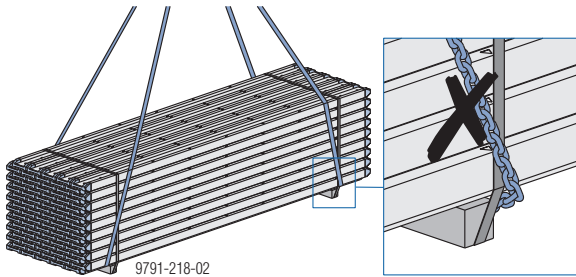

**NOTICE**

When transporting loose beams without strapping, make sure that the beams cannot slip!

- Always sort beams for stacking, in other words do not stack beams N and P together in a mixed stack.

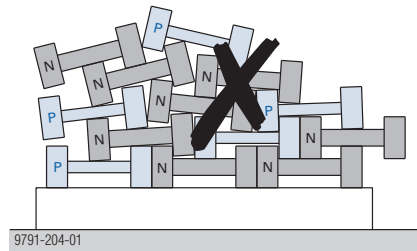

- Always stack Beams H20 N "sorted by web thickness", in other words do not put beams of different web thickness in the same row of beams.

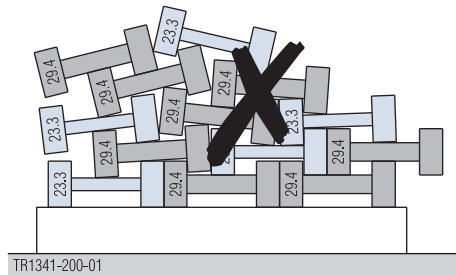

## Stacked beams

- max. 2800 kg per stack

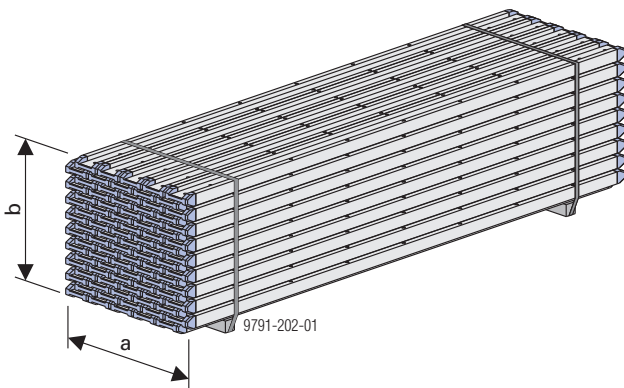

	Beam lengths		
	< 5.90m	5.90m	> 5.90m to 12.00m

Max. number of beams per stack	100	60	50
Minimum number of timber supports (min. 10 x 8 x 108 cm)	2	2	3
Size a	108 cm	108 cm	108 cm
Size b for Beam XT20	123 cm	79 cm	68 cm
Size b for Beam H20 N	116 cm	75 cm	65 cm
Size b for Beam H20 P	115 cm	74 cm	64 cm

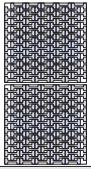
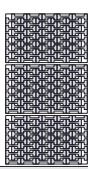
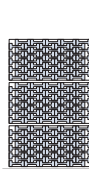
Max. number of stacks on top of one another	2	3	3
	 9791-224-01	 9791-224-03	 9791-224-02



**WARNING**

Random mixing of old and new H20 N beams can cause the stack of beams to topple!

- Stack the beams in such a way that the top edge of the package is level.

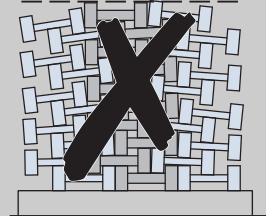
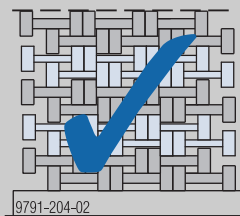

Beams produced after the start of 2023 bear a PEFC mark on the broad side of the flange.

This can be used as one way of distinguishing between the new beams and the older beams.



- ▶ Always use edge protectors when strapping beams together. Edge protectors can be padding made of plastic, wood or cardboard.

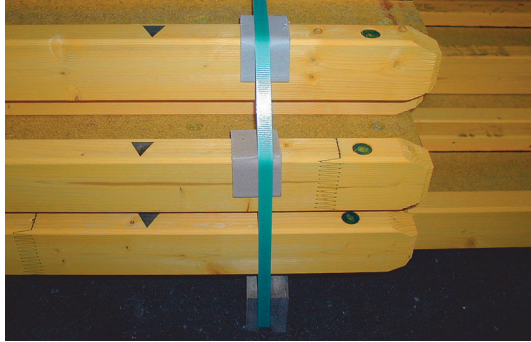

## Ground conditions for stacking

---

- Maximum angle of inclination of ground 3%.
- The ground on which the stack is to be placed must be adequately firm and level. Best-case conditions are concreted or paved storage areas.
- Storage on asphalt:  
Depending on the parts stored, place wooden battens, strips of formwork sheeting or metal sheet between the parts and the asphalt surface to ensure that the weight is adequately spread.
- Storage on other surfaces (sand, gravel...):  
Adopt suitable measures for storage (e.g. place thick plywood sheets underneath the loads).

## Protection from wind and weather

---

- Protect stacked beams from extreme climatic influences such as exposure to sunshine or moisture by roofing them over or covering them with breathable tarpaulins. This reduces cracking, fungal attack and mould.
- Only cover them – never envelope them completely.

## Doka beam XT20



96437-800

Timber formwork beam XT20 is a light, solid-web beam with increased load-bearing capacity pursuant to approval issued by the German Institute of Construction Engineering (Deutsches Institut für Bautechnik, DIBt) with polyurethane beam-end reinforcement for a longer life cycle.

### Basic design concept

- Solid-web beam made of wood and wood-based materials pursuant to national technical approval n° Z-9.1-920.
- Flange is spruce, automatically machine-graded, and 100 % of the beam flanges are tested by the tensile loading test method (proof-loading).
- Poplar-plywood web with grey web coating.
- Polyurethane end reinforcement.
- 2 system holes at each beam end.

### Glue-bonding

Glues/adhesives used are tested and approved systems for load-bearing applications indoors and outdoors.

### Surfaces

- Yellow varnish without wood preservatives.
- Grey web coating.

### Technical data

#### Note:

All values in the tables are based on a wood moisture content of  $12 \pm 2\%$  on delivery.

Changes in the wood's moisture content can have effects on the weight, dimensions and mechanical properties of the beam.

Doka beams XT20 are designed for loading in the direction of the height of the beam.

#### Dimensions:

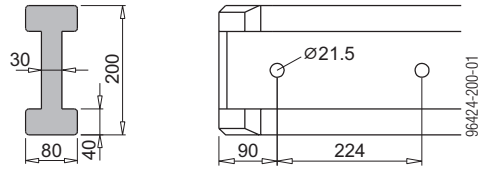

Figures given in mm

#### Lengths:

Length [m]	
1.80 - 5.90	with end reinforcement
> 5.90 - 12.00	trimmed off straight

For details, see article list

#### Tolerances:

	Tolerance
Height	$\pm 1.0$ mm
Length up to 6 m	+ 0 / - 3.0 mm
Length > 6 m	$\pm 3.0$ mm

Weight: 5.0 kg/lin.m

#### Mechanical properties (in accordance with Approval n° Z-9.1-920):

Perm. shear force Q [kN]	15.0 (16.5) <sup>1)</sup>
Perm. moment M [kNm]	7.0
Flexural stiffness EI [kNm <sup>2</sup> ]	585
Perm. span [m]	4.50

<sup>1)</sup> Pursuant to Approval n° Z-9.1-920, 16.5 kN can be assumed as permitted shear force, given compliance with the permitted reaction force of 30 kN.

These values allow for a  $\gamma_F = 1.5$ , a  $k_{mod}$  of 0.9 and a  $\gamma_M = 1.3$ . Under different conditions of use and/or with moisture content > 20%, the values have to be modified accordingly.

### Use

- For use in wall-formwork and slab-formwork systems, tunnel formwork, automatic climbing formwork, etc.
- These beams have the same dimensions as Doka beams H20 but are stronger, so the reduction in material quantities in slab and wall formwork is considerable..
- The polyurethane beam-end reinforcement contributes to a longer life cycle.
- Beam-flange markings in a 50 cm grid for Dokaflex and Dokaflex 30 tec systems.



The beams can be labelled with the client's name if desired.



## Doka beam H20 top

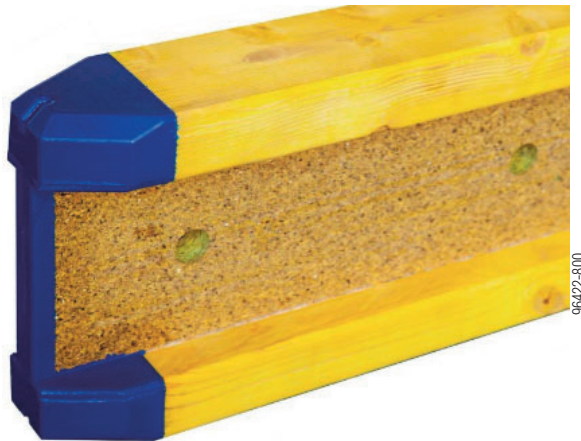

Timber formwork beam H20 top is a solid-web beam in accordance with EN 13377 with innovative polyurethane end reinforcement for increased resistance to mechanical stresses and strains.

### Basic design concept

- Solid-web beam made of wood and wood-based materials to EN 13377.
- Wood for the flanges is spruce, automatically machine-graded, and 100 % of the beam flanges are tested by the tensile loading test method (proof-loading).
- Web
  - H20 P: special flat compressed particle board.
  - H20 N: three-ply sheet.
- Polyurethane end reinforcement
- 2 system holes at each beam end

### Glue-bonding

Glues/adhesives used are tested and approved systems for load-bearing applications indoors and outdoors.

### Surfaces

Yellow varnish without wood preservatives.

### Technical data

#### Note:

All values in the tables are based on a wood moisture content of  $12 \pm 2\%$  on delivery.

Changes in the wood's moisture content can have effects on the weight, dimensions and mechanical properties of the beam.

Doka beams H20 top are designed for loading in the direction of the height of the beam.

#### Dimensions:

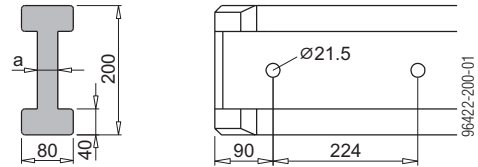

Figures given in mm

Type of beam	Thickness of web a [mm]	Weight [kg/lin.m]
N <sup>1)</sup>	23.3	4.4
N <sup>2)</sup>	29.4	4.7
P	22.0	5.3

1) ... manufactured from 2023 onwards

2) ... manufactured until 2022

#### Lengths:

Length [m]	
1.80 - 5.90	with end reinforcement

For details, see article list

#### Tolerances:

	Tolerance
Height	$\pm 1.0$ mm
Length	+ 0 / - 3.0 mm

#### Mechanical properties

(permissible values from EN 13377 Annex E):

Permitted shear force Q [kN]	11.0
Permitted moment M [kNm]	5.0
Flexural stiffness EI [kNm <sup>2</sup> ]	450
Permitted span [m]	4.00

These values allow for a  $\gamma_F = 1.5$ , a  $k_{mod}$  of 0.9 and a  $\gamma_M = 1.3$ . Under different conditions of use and/or with moisture content > 20%, the values have to be modified accordingly.

### Use

For use in wall-formwork and slab-formwork systems, tunnel formwork, automatic climbing formwork, etc. Beam-flange markings in a 50 cm grid for Dokaflex and Dokaflex 30 tec systems.

The innovative polyurethane end reinforcement leads to a significant reduction in damage to the beam ends.

#### Note:

The beams can be labelled with the client's name if desired.

## Doka beam H20 pro



The timber formwork beam H20 pro is a solid-web beam to EN 13377 with high-quality polyurethane end reinforcement for protection against splintering and moisture.

### Basic design concept

- Solid-web beam made of wood and wood-based materials to EN 13377.
- Wood for the flanges is spruce, automatically machine-graded, and 100 % of the beam flanges are tested by the tensile loading test method (proof-loading).
- Web made of 3-ply sheet
- Polyurethane end reinforcement
- 2 system holes at each beam end

### Glue-bonding

Glues/adhesives used are tested and approved systems for load-bearing applications indoors and outdoors.

### Surfaces

Yellow varnish without wood preservatives.

### Technical data

#### Note:

All values in the tables are based on a wood moisture content of  $12 \pm 2\%$  on delivery.

Changes in the wood's moisture content can have effects on the weight, dimensions and mechanical properties of the beam.

Doka beams H20 pro are designed for loading in the direction of the height of the beam.

#### Dimensions:

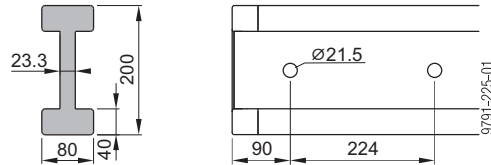

Figures given in mm

**Weight:** 4.4 kg/lin.m

#### Lengths:

Length [m]	
1.80 - 5.90	with end reinforcement

For details, see article list

#### Tolerances:

	Tolerance
Height	$\pm 1.0$ mm
Length	+ 0 / - 3.0 mm

#### Mechanical properties

(permissible values from EN 13377 Annex E):

Permitted shear force Q [kN]	11.0
Permitted moment M [kNm]	5.0
Flexural stiffness EI [kNm <sup>2</sup> ]	450
Permitted span [m]	4.00

These values allow for a  $\gamma_F = 1.5$ , a  $k_{mod}$  of 0.9 and a  $\gamma_M = 1.3$ . Under different conditions of use and/or with moisture content  $> 20\%$ , the values have to be modified accordingly.

### Use

For use in wall-formwork and slab-formwork systems, tunnel formwork, automatic climbing formwork, etc. Beam-flange markings in a 50 cm grid for Dokaflex and Dokaflex 30 tec systems.

The high-quality polyurethane end reinforcement is captively integrated and extends the beam's service life.

#### Note:

The beams can be labelled with the client's name if desired.

## Doka beam H20 eco



Timber formwork beam H20 eco is a solid-web beam in accordance with EN 13377 with proven end reinforcement in the form of bevelled beam ends and extra plastic rivet in the beam flange.

### Basic design concept

- Solid-web beam made of wood and wood-based materials to EN 13377.
- Wood for the flanges is spruce, automatically machine-graded, and 100 % of the beam flanges are tested by the tensile loading test method (proof-loading).
- Web
  - H20 P: special flat compressed particle board
  - H20 N: three-ply sheet
- End reinforcement in the form of bevelled ends with plastic rivet in the beam flange.
- 2 system holes at each beam end

### Glue-bonding

Glues/adhesives used are tested and approved systems for load-bearing applications indoors and outdoors.

### Surfaces

Yellow varnish without wood preservatives.

### Technical data

#### Note:

All values in the tables are based on a wood moisture content of  $12 \pm 2\%$  on delivery.

Changes in the wood's moisture content can have effects on the weight, dimensions and mechanical properties of the beam.

Doka beams H20 eco are designed for loading in the direction of the height of the beam.

#### Dimensions:

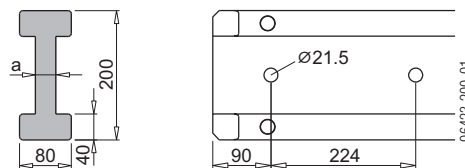

Figures given in mm

Type of beam	Thickness of web a [mm]	Weight [kg/lin.m]
N <sup>1)</sup>	23.3	4.4
N <sup>2)</sup>	29.4	4.7
P	22.0	5.3

1) ... manufactured from 2023 onwards

2) ... manufactured until 2022

#### Lengths:

Length [m]	
< 1.80	trimmed off straight
1.80 - 9.00	with end reinforcement
> 9.00 - 12.00	trimmed off straight

For details, see article list.

#### Tolerances:

	Tolerance
Height	$\pm 1.0$ mm
Length up to 6 m	+ 0 / - 2,0 mm
Length > 6 m	$\pm 3.0$ mm

#### Mechanical properties

(permissible values from EN 13377 Annex E):

Permitted shear force Q [kN]	11.0
Permitted moment M [kNm]	5.0
Flexural stiffness EI [kNm <sup>2</sup> ]	450
Permitted span [m]	4.00

These values allow for a  $\gamma_F = 1.5$ , a  $k_{mod}$  of 0.9 and a  $\gamma_M = 1.3$ . Under different conditions of use and/or with moisture content > 20%, the values have to be modified accordingly.

- **Fire behaviour:** D - s2, d0

### Use

For use in wall-formwork and slab-formwork systems, tunnel formwork, automatic climbing formwork, etc. Beam-flange markings in a 50 cm grid for the Dokaflex and Dokaflex 30 tec systems.

#### Note:

The beams can be labelled with the client's name if desired.

# Deflection diagram

## Doka beam XT20

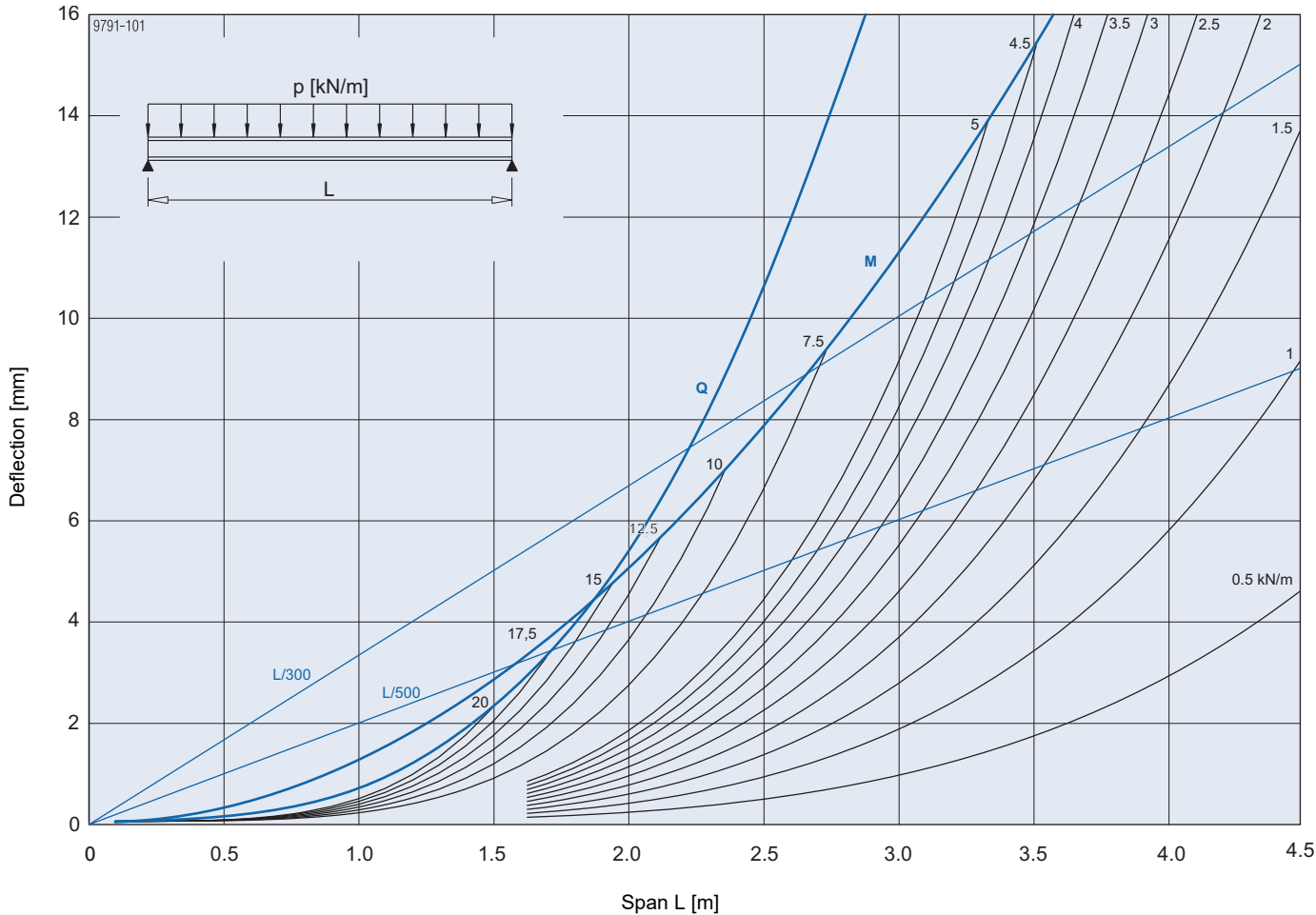

M ... permitted bending moment  
Q ... permitted shear force  
p ... actual load (service load)

# Doka beams H20 top | H20 pro | H20 eco

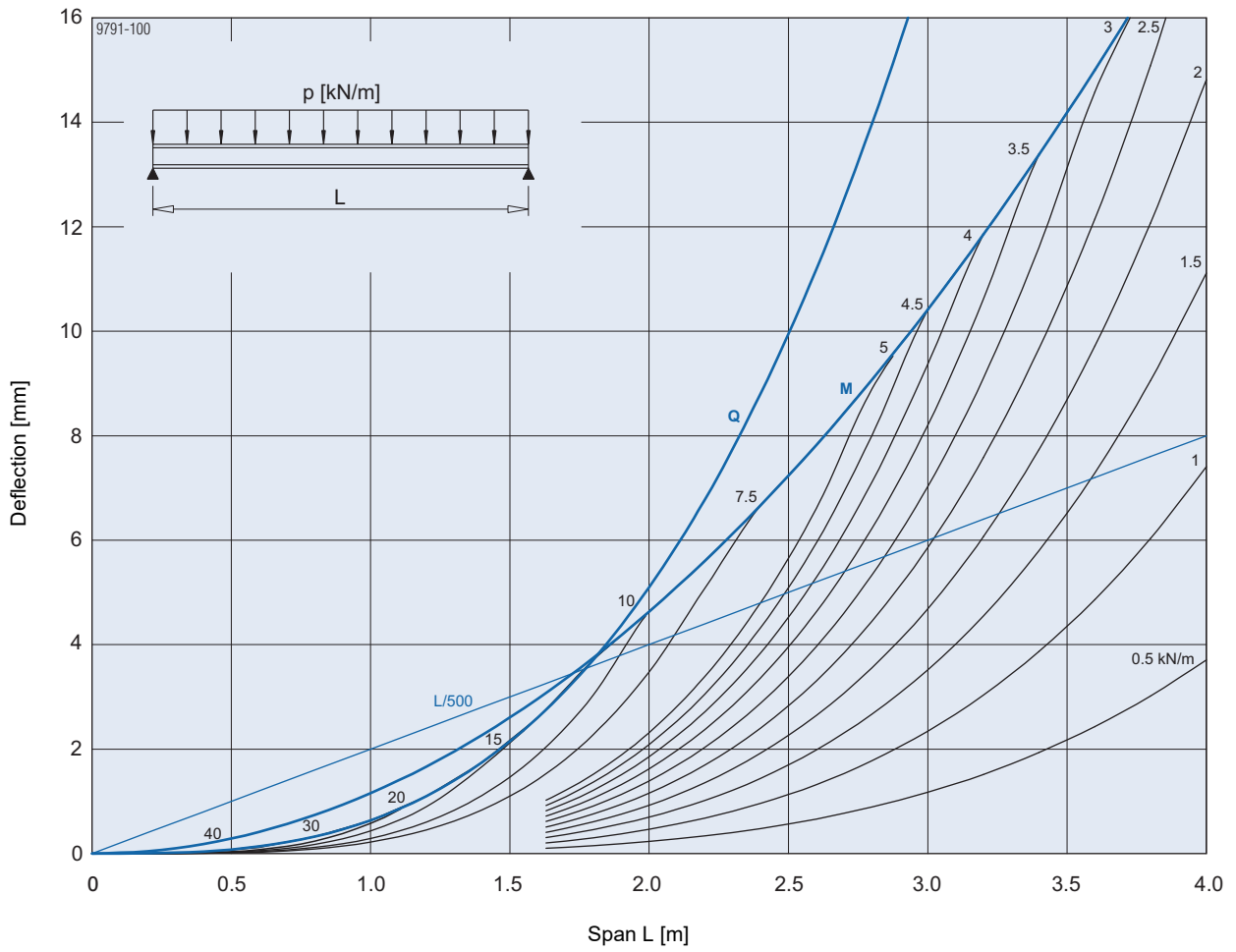

M ... permitted bending moment  
 Q ... permitted shear force  
 p ... actual load (service load)

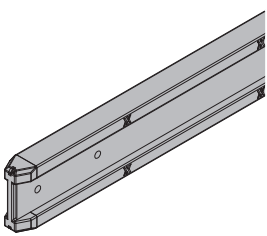
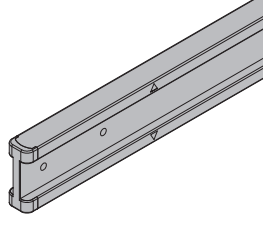
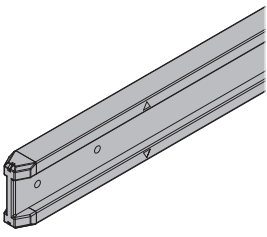
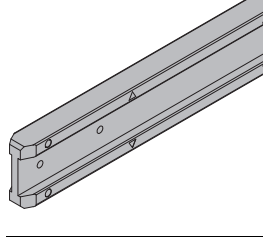
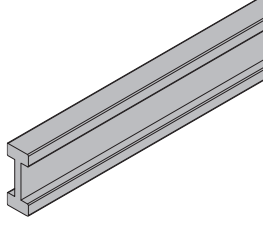
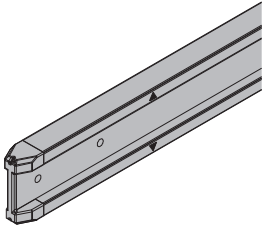
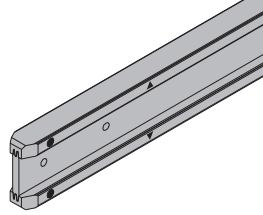
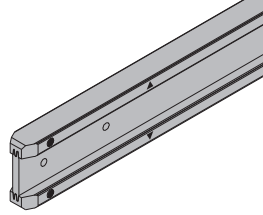
	[kg]	Article N°		[kg]	Article N°
Doka beam XT20 1.80m	9.0	188031000	Doka beam H20 pro N 1.80m	7.9	189076000
Doka beam XT20 2.45m	12.3	188033000	Doka beam H20 pro N 2.45m	10.8	189077000
Doka beam XT20 2.65m	13.3	188034000	Doka beam H20 pro N 2.65m	11.7	189078000
Doka beam XT20 2.90m	14.5	188035000	Doka beam H20 pro N 2.90m	12.8	189079000
Doka beam XT20 3.30m	16.5	188036000	Doka beam H20 pro N 3.30m	14.5	189080000
Doka beam XT20 3.60m	18.0	188037000	Doka beam H20 pro N 3.60m	15.8	189081000
Doka beam XT20 3.90m	19.5	188038000	Doka beam H20 pro N 3.90m	17.2	189082000
Doka beam XT20 4.50m	22.5	188039000	Doka beam H20 pro N 4.50m	19.8	189083000
Doka beam XT20 4.90m	24.5	188040000	Doka beam H20 pro N 4.90m	21.6	189084000
Doka beam XT20 5.35m	26.8	188041000	Doka beam H20 pro N 5.90m	26.0	189085000
Doka beam XT20 5.90m	29.5	188042000	Doka beam H20 pro N .....m	4.4	189086000
Doka beam XT20 .....m	5.0	188043000	Doka beam H20 pro N .....m BS	4.4	189087000
Doka beam XT20 .....m BS	5.0	188044000	Doka-Träger H20 pro N		
Doka-Träger XT20					
					
Varnished yellow Grey			Varnished yellow		
Doka beam H20 top N 1.80m	8.5	189011000	Doka beam H20 eco N 1.80m	8.5	189283000
Doka beam H20 top N 2.45m	11.5	189012000	Doka beam H20 eco N 2.45m	11.5	189271000
Doka beam H20 top N 2.65m	12.5	189013000	Doka beam H20 eco N 2.65m	12.5	189272000
Doka beam H20 top N 2.90m	13.6	189014000	Doka beam H20 eco N 2.90m	13.6	189273000
Doka beam H20 top N 3.30m	15.5	189015000	Doka beam H20 eco N 3.30m	15.5	189284000
Doka beam H20 top N 3.60m	16.9	189016000	Doka beam H20 eco N 3.60m	16.9	189285000
Doka beam H20 top N 3.90m	18.3	189017000	Doka beam H20 eco N 3.90m	18.3	189276000
Doka beam H20 top N 4.50m	21.2	189018000	Doka beam H20 eco N 4.50m	21.2	189286000
Doka beam H20 top N 4.90m	23.0	189019000	Doka beam H20 eco N 4.90m	23.0	189277000
Doka beam H20 top N 5.90m	27.7	189020000	Doka beam H20 eco N 5.90m	27.7	189287000
Doka beam H20 top N .....m	4.7	189010000	Doka beam H20 eco N .....m	4.7	189299000
Doka beam H20 top N .....m BS	4.7	189021000	Doka beam H20 eco N .....m BS	4.7	189289000
Doka-Träger H20 top N			Doka-Träger H20 eco N		
					
Varnished yellow			Varnished yellow		
Doka beam H20 top P 1.80m	9.5	189701000	Doka beam H20 eco N 1.25m	5.9	189282000
Doka beam H20 top P 2.45m	13.0	189702000	Doka beam H20 eco N 12.00m	56.4	189288000
Doka beam H20 top P 2.65m	14.1	189703000	Doka-Träger H20 eco N		
Doka beam H20 top P 2.90m	15.4	189704000			
Doka beam H20 top P 3.30m	17.5	189705000			
Doka beam H20 top P 3.60m	19.1	189706000			
Doka beam H20 top P 3.90m	20.7	189707000			
Doka beam H20 top P 4.50m	23.9	189708000			
Doka beam H20 top P 4.90m	26.0	189709000			
Doka beam H20 top P 5.90m	31.3	189710000			
Doka beam H20 top P .....m	5.3	189700000			
Doka beam H20 top P .....m BS	5.3	189711000			
Doka-Träger H20 top P					
					
Varnished yellow					
Doka beam H20 eco P 1.80m	9.5	189940000	Doka beam H20 eco P 1.80m	9.5	189940000
Doka beam H20 eco P 2.45m	13.0	189936000	Doka beam H20 eco P 2.45m	13.0	189936000
Doka beam H20 eco P 2.65m	14.1	189937000	Doka beam H20 eco P 2.65m	14.1	189937000
Doka beam H20 eco P 2.90m	15.4	189930000	Doka beam H20 eco P 2.90m	15.4	189930000
Doka beam H20 eco P 3.30m	17.5	189941000	Doka beam H20 eco P 3.30m	17.5	189941000
Doka beam H20 eco P 3.60m	19.1	189942000	Doka beam H20 eco P 3.60m	19.1	189942000
Doka beam H20 eco P 3.90m	20.7	189931000	Doka beam H20 eco P 3.90m	20.7	189931000
Doka beam H20 eco P 4.50m	23.9	189943000	Doka beam H20 eco P 4.50m	23.9	189943000
Doka beam H20 eco P 4.90m	26.0	189932000	Doka beam H20 eco P 4.90m	26.0	189932000
Doka beam H20 eco P 5.90m	31.3	189955000	Doka beam H20 eco P 5.90m	31.3	189955000
Doka beam H20 eco P .....m	5.3	189999000	Doka beam H20 eco P .....m	5.3	189999000
Doka beam H20 eco P .....m BS	5.3	189957000	Doka beam H20 eco P .....m BS	5.3	189957000
Doka-Träger H20 eco P			Doka-Träger H20 eco P		
					
Varnished yellow			Varnished yellow		

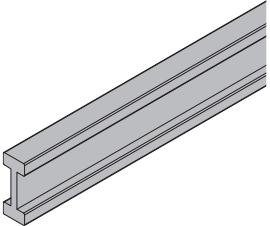
	[kg]	Article N°	[kg]	Article N°
<b>Doka beam H20 eco P 1.10m</b>	<b>5.8</b>	<b>189958000</b>		
<b>Doka beam H20 eco P 1.25m</b>	<b>6.6</b>	<b>189939000</b>		
<b>Doka beam H20 eco P 12.00m</b>	<b>63.6</b>	<b>189993000</b>		
Doka-Träger H20 eco P				
 Varnished yellow				
<b>Timber varnish yellow 5l</b>	<b>5.0</b>	<b>176005000</b>		
Holzlasur gelb 5l				



Formwork & Scaffolding.  
**We make it work.**

---



[www.doka.com/timber-formwork-beams](https://www.doka.com/timber-formwork-beams)