

Sikker oppføring - støpeplattform U

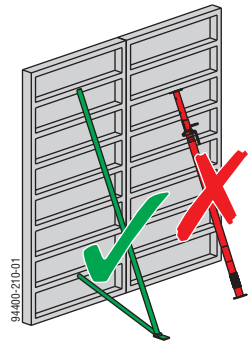

94400-100



94400-210-01

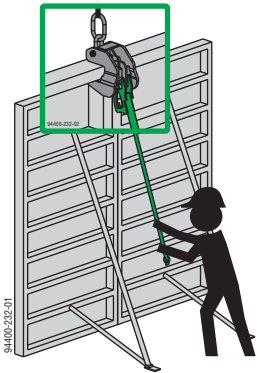

94400-210-01

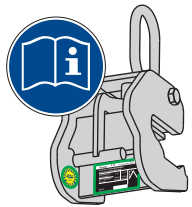

Denne posteren erstatter ikke den respektive systembrukerinformasjonen. www.doka.com/downloadcenter

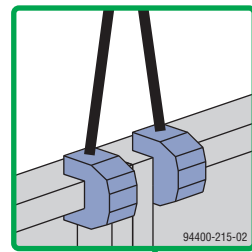

94400-215-02

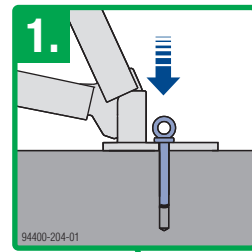

1.

94400-204-01

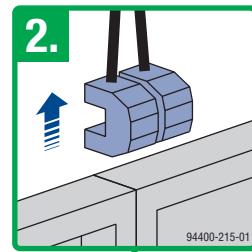

2.

94400-215-01

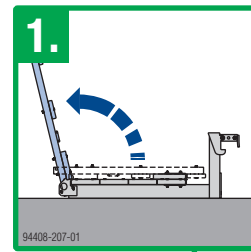

1.

94400-207-01

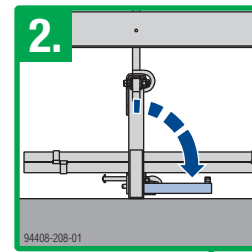

2.

94400-208-01

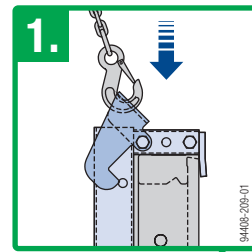

1.

94400-209-01

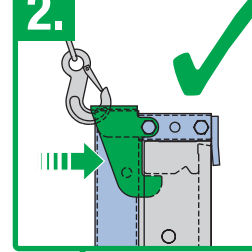

2.

94400-210-01

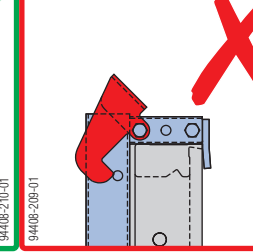

94400-209-01

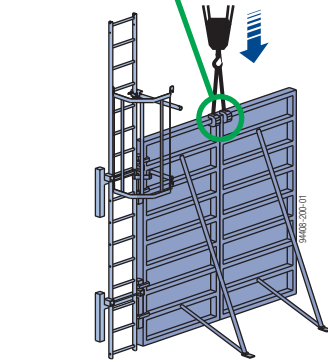

94400-209-01

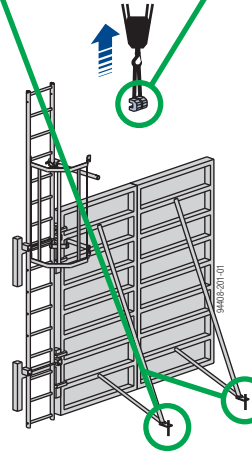

94400-209-01

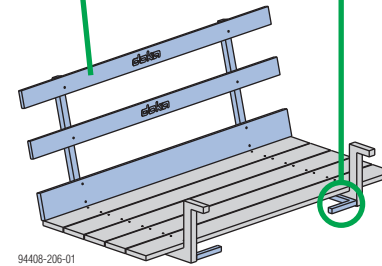

94400-206-01

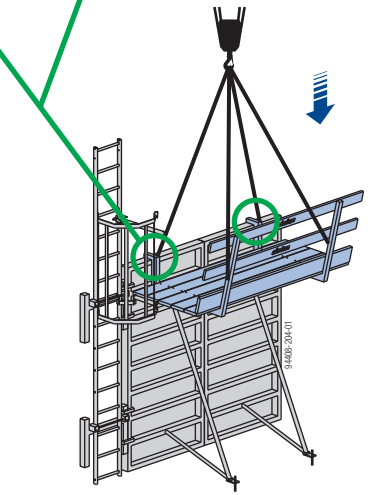

94400-209-01

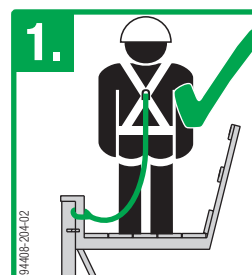

1.

94400-204-02

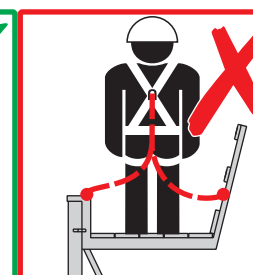

1.

94400-204-02

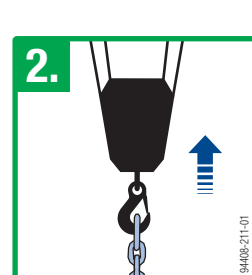

2.

94400-211-01

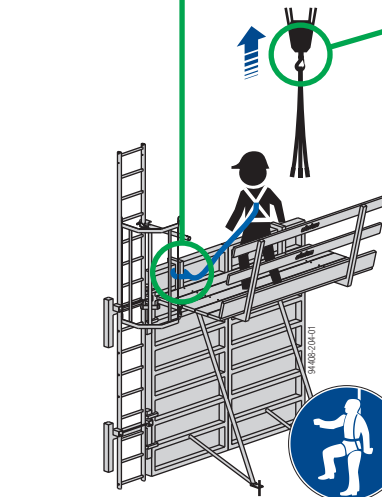

94400-209-01

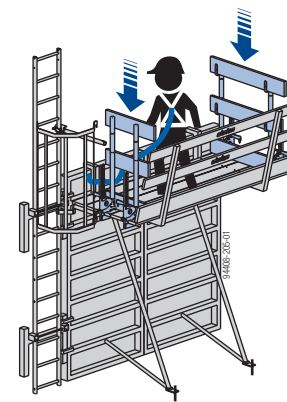

94400-209-01

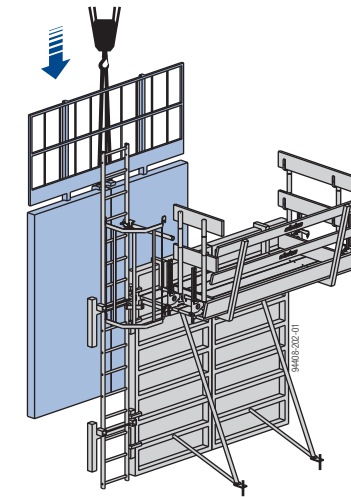

94400-209-01

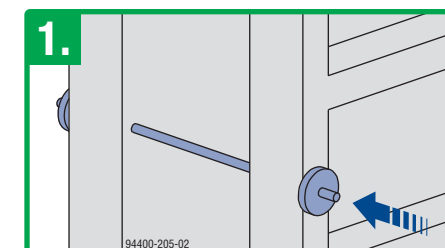

1.

94400-205-02

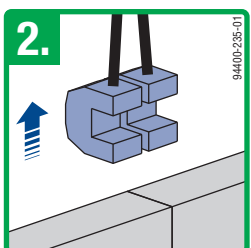

2.

94400-235-01

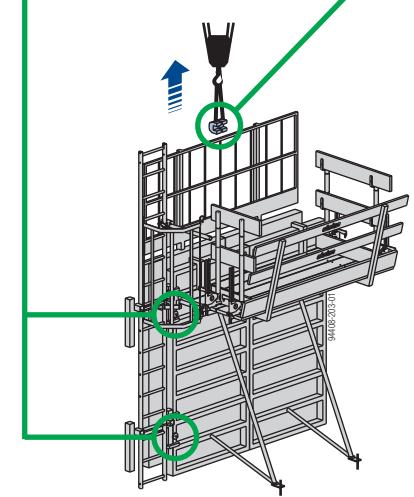

94400-209-01